













Assembly Instruction

ITEM#:3614-04 END TABLE

PARTS LIST				HARDWARE LIST				
A		Top frame	1 PC	1		Bolt	1/4"*5/8"	12 PCS
B		Glass top	1 PC	2		Bolt	1/4"*5/8"	8 PCS
C		Lower leg frame	1 PC	3		Flat washer	1/4"	8 PCS
D		Upper leg frame	1 PC	4		Allen key	4mm	1 PC
				5		Metal plate	100*50*3mm	4 PCS
				6		Metal rail	150*150*3mm	1 PC

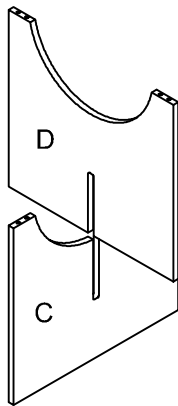

STEP 1

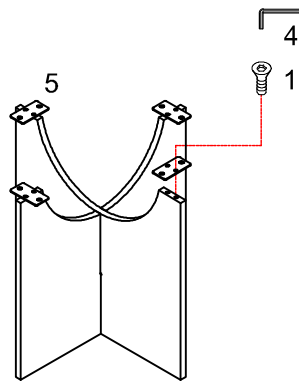

STEP 2

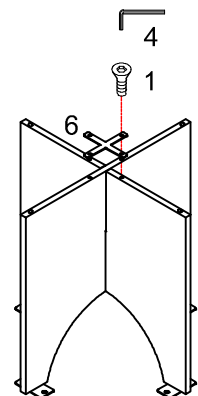

STEP 3

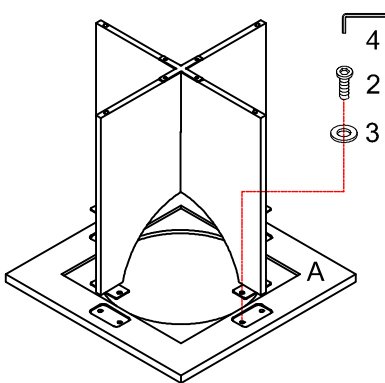

STEP 4

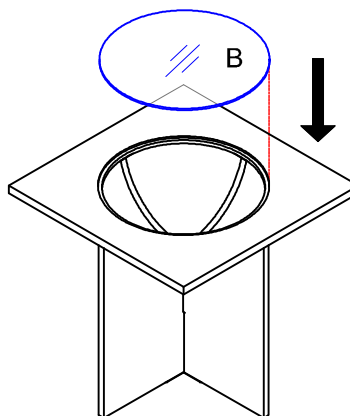

STEP 5

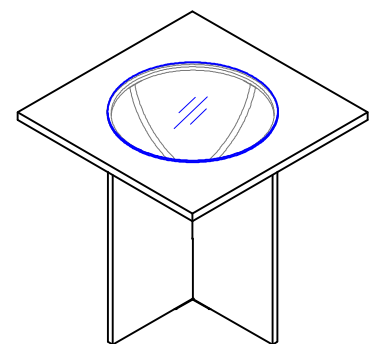

For items use on wooden floor, hard surfaces or carpets, it is recommended to install protective pads under all legs and supports to avoid/ prevent from damages/ scratches and discoloration.