





Assembly Instruction

ITEM NO.: 8440GRY-3
Double Reclining Sofa

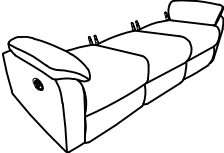
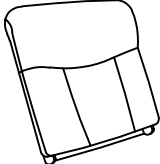
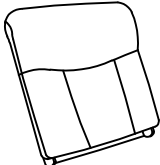

Note: Do not use power tools for assembly. Power tools increase the risk of over tightening which lead to splitting or cracking the wood.

Component list

No	Drawing	Qty	Description
A		1	SEAT
B		1	LSF BACK REST
C		1	MIDDLE BACK REST
D		1	RSF BACK REST

Step #1

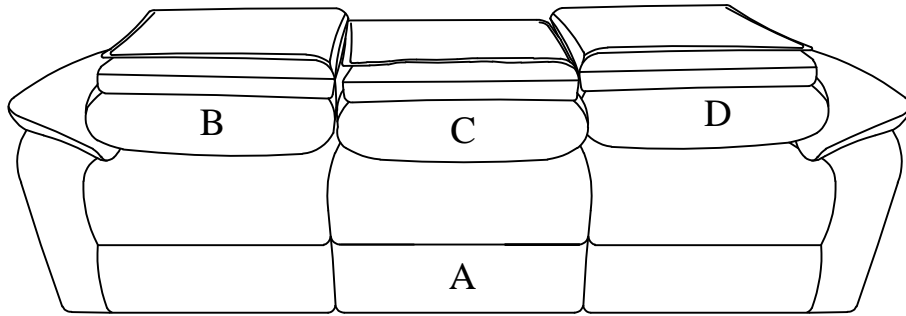

Step #2

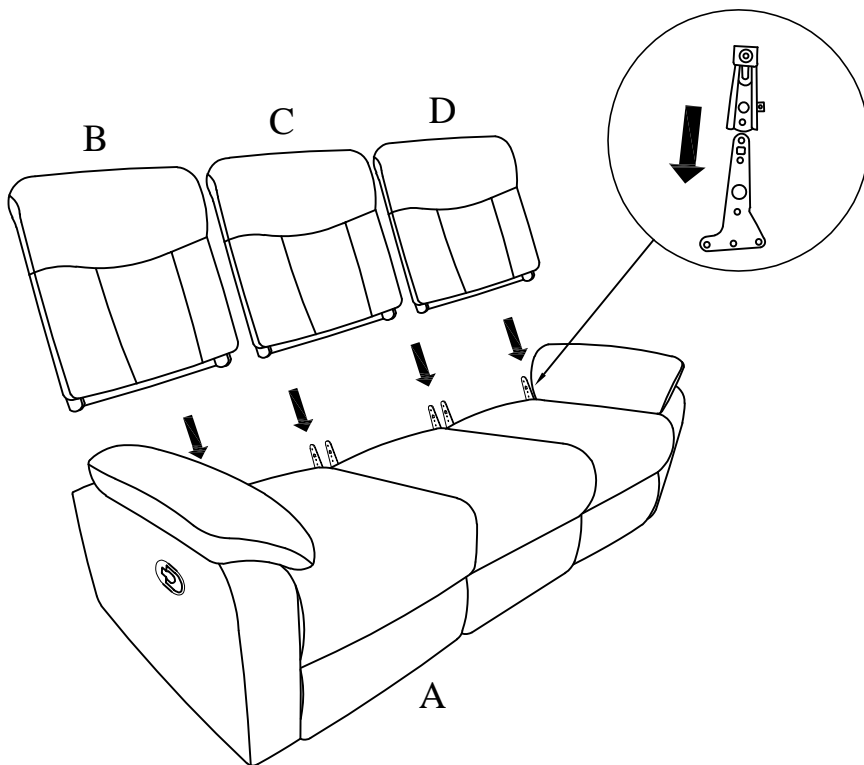

Step #3

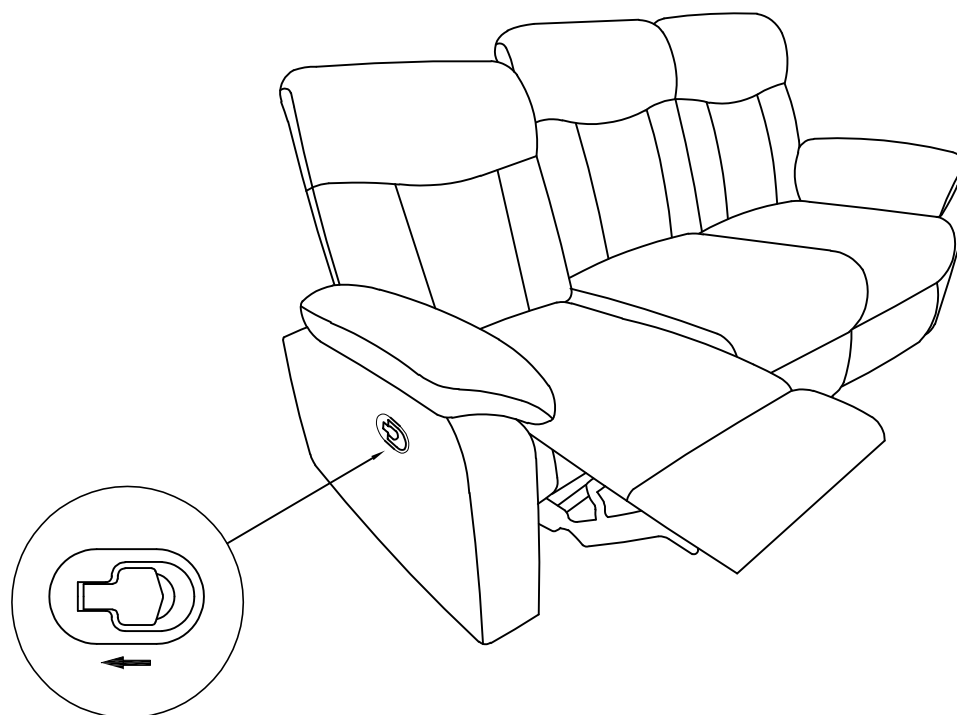

Pull to recline the chair

Care Instruction for Chenille Furniture:

In order to maintain the original appearance of your Chenille Furniture, please follow below simple care procedures:

- Avoid exposing furniture directly to sunlight or heating and air conditioning outlets. Sunlight and or exposure to heating and air conditioning outlets will fade/damage Chenille.
- Vacuum or wipe with a soft cloth to remove dust.
- Hardware may loosen over time. Periodically check to make sure all connection are tight, Re-tighten if necessary.



For items use on wooden floor, hard surfaces or carpets, it is recommended to Install protective pads under all legs and supports to avoid/prevent from damages/scratches and discoloration.