



ASSEMBLY INSTRUCTIONS
SOFA, 5 PILLOWS
ITEM NO: 9178NBR-3
9178SVNBR-3









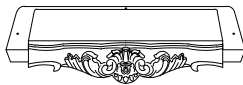

Thank you for being our valued customer. Be sure to check all packing materials carefully for small parts which may have come loose inside the carton during shipment. Identify and count all items and compare them with the parts list below.

CAUTION: Read the Instructions carefully before assembly.

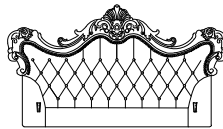

1. We recommend that you assemble this product with the assistance of another person to eliminate the risk of injury to the product during assembly.

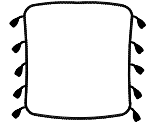
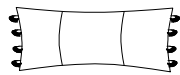
2. When you want to reposition the product, please always "LIFT & MOVE".

NOTE: Do not use power tools for assembly. Power tools increase the risk of over tightening which leads to splitting or cracking the wood.

PARTS LIST			
NO.	DESCRIPTION	PART NAME	Q"TY(PC)
1	SEAT FRAME		1
2	LSF ARM		1
3	RSF ARM		1
4	LSF SEAT CUSHION		1
5	MIDDLE SEAT CUSHION		1
6	RSF SEAT CUSHION		1
7	BACKREST (90½" x 41" x 12")		1
8	BRUSH FRINGE PILLOW (18½" x 18½" x 6½")		2
9	TASSEL FRINGE PILLOW (20¾" x 11½" x 5")		2
10	KIDNEY PILLOW (20¾" x 11½" x 5")		1
11	WOODEN SUPPORT LEG		1

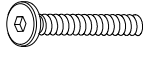
HARDWARE LIST

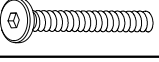
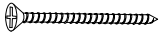
NO.	PART NAME	SKETCH	Q"TY(PC)
Ⓐ	ALLEN KEY Ø5 x16"		1
Ⓑ	BOLT Ø5/16x2 3/4"		4
Ⓒ	FLAT WASHER Ø5/16"x7/8"		8
Ⓓ	LOCK WASHER Ø5/16"x1/2"		8
Ⓔ	BOLT Ø5/16x3 1/8"		4
Ⓕ	SCREW (M4x2-3/8")		2

How to assemble:

STEP 1:

Lay the seat frame (1) to reach the holes to secure the bolts for the arms. Align and assemble the LSF arm (2) and RSF arm (3) to the seat frame (1) by using the Allen Key (A) with hardware C, D, and B.

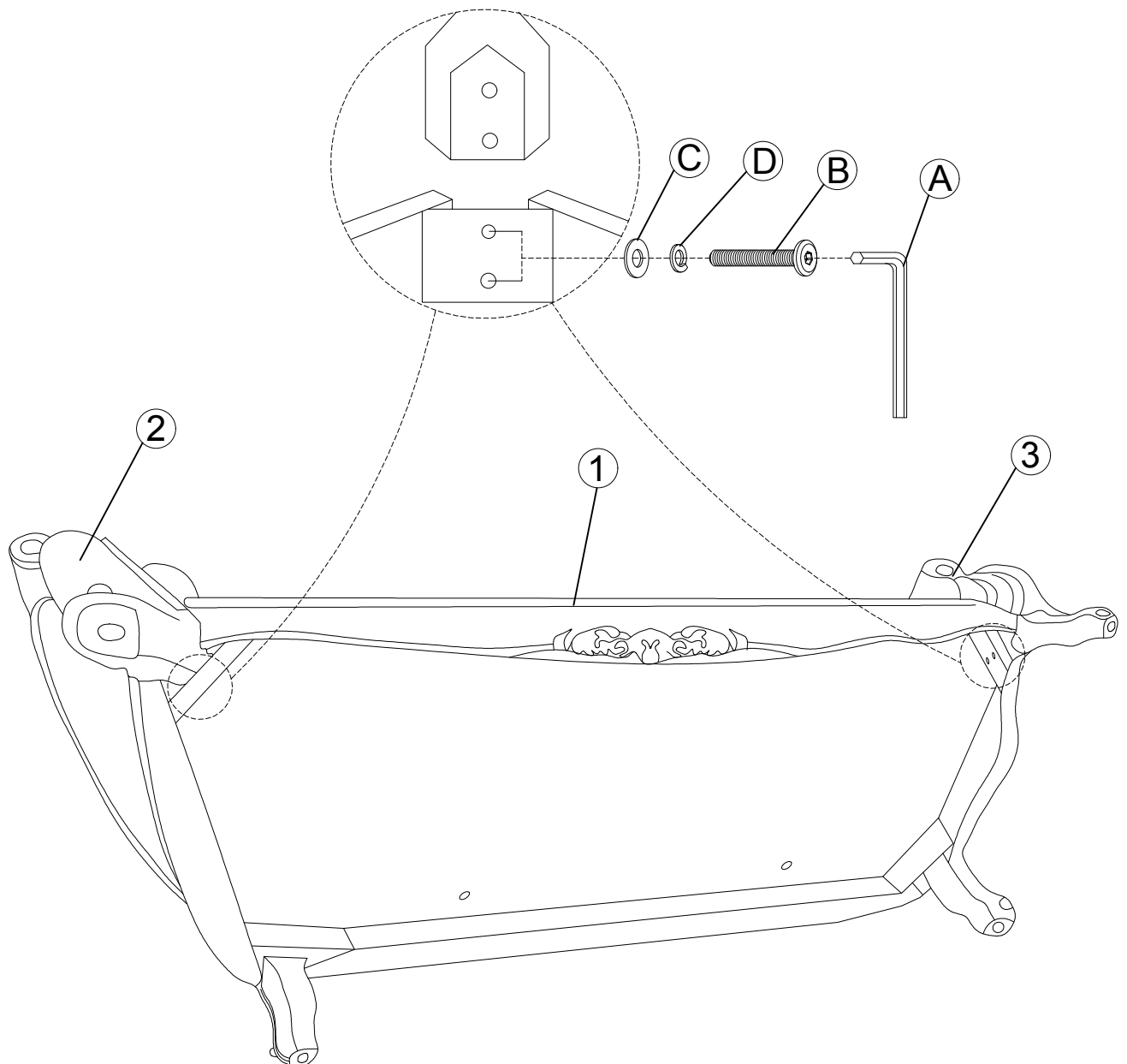

STEP 2:

Align and attach LSF arm (2) and RSF arm (3) to the seat frame (1) using bolt (E) with that washer (C) and lock washer (D) and securing with Allen Key (A). Flip the chair over, then secure the bottom with screws (F) using a screwdriver.

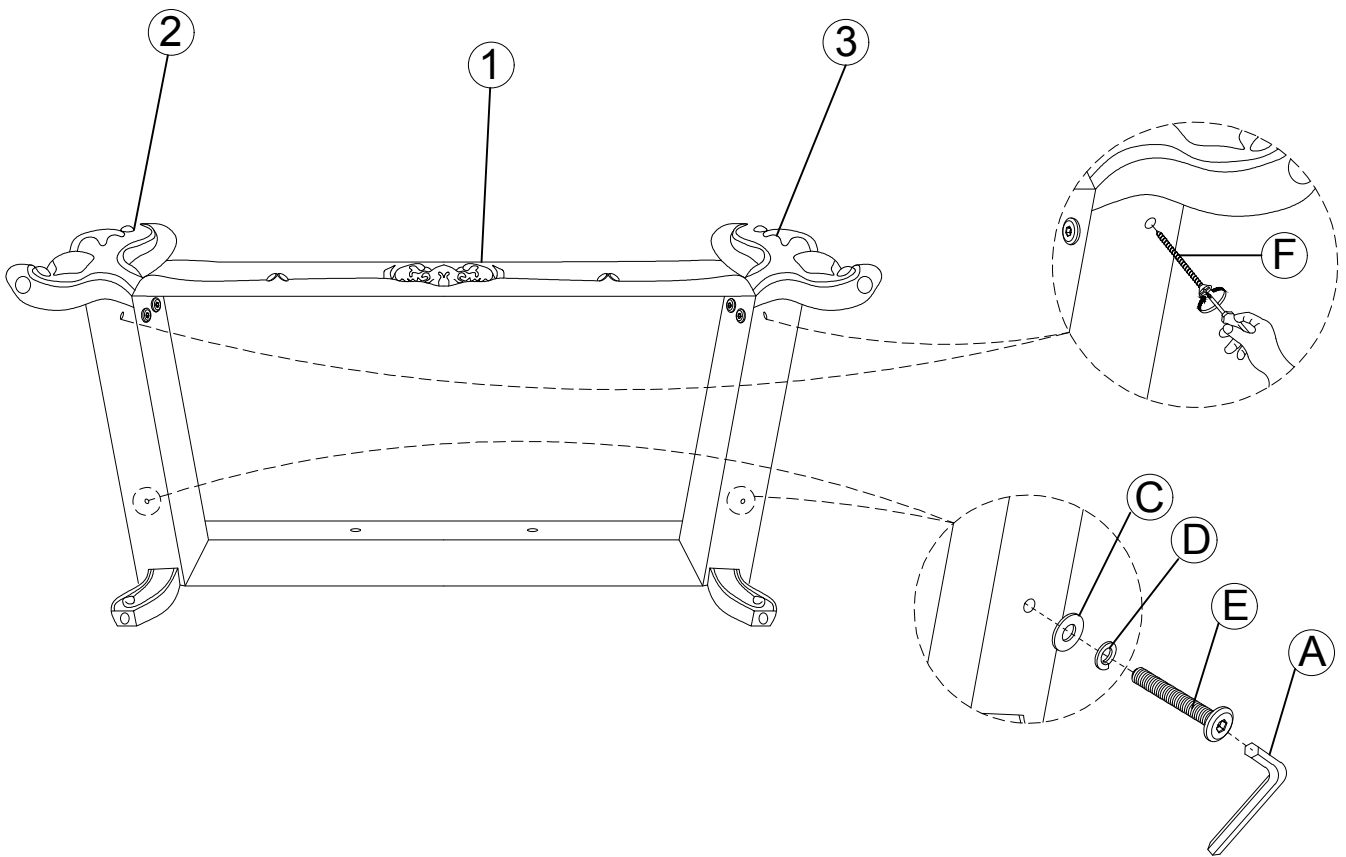

STEP 3:

Assemble and secure the front legs of the LSF arm (2) and RSF arm (3) to the seat frame (1), Screw the wooden support legs (11).

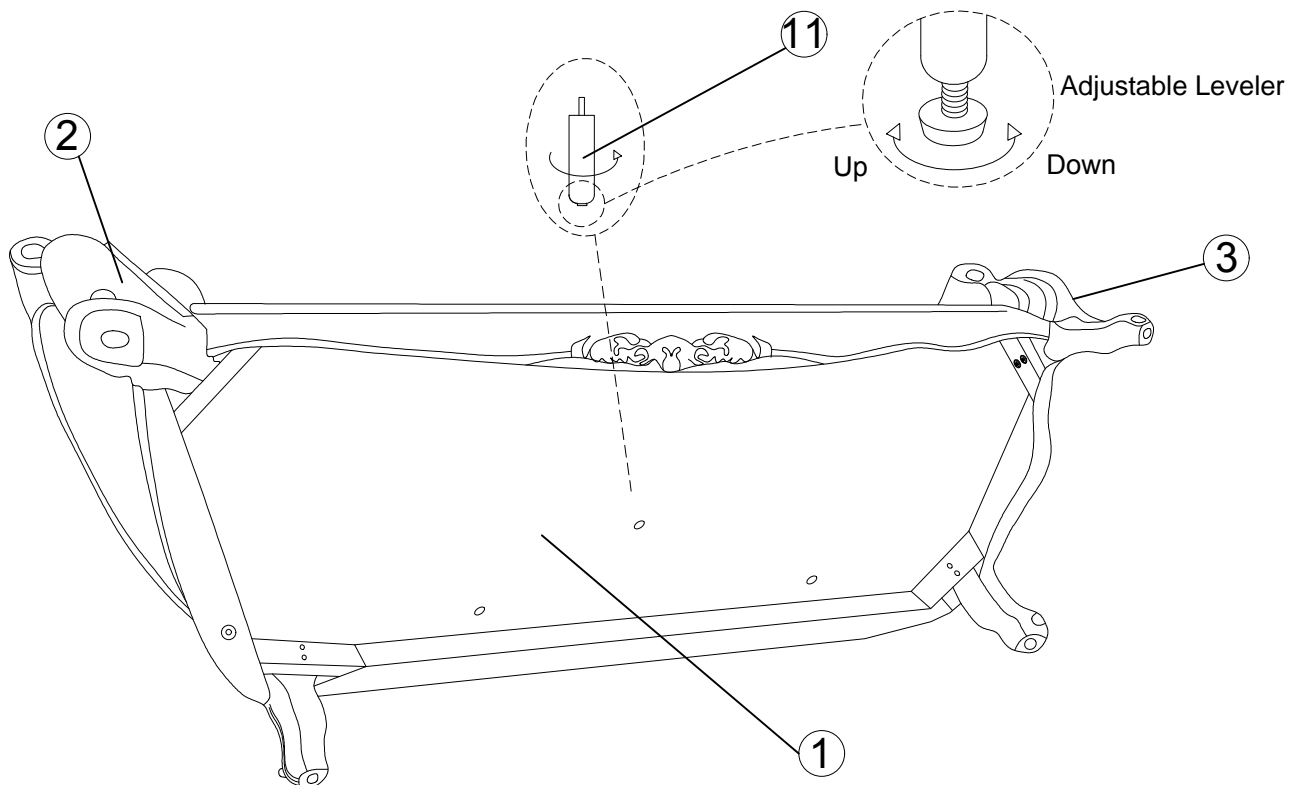

STEP 4:

Attach Backrest (7) to the LSF arm (2) and RSF arm (3) by sliding in the backrest all the way until it is secured and using bolt (E) with that washer (C) and lock washer (D) and securing with Allen Key (A).

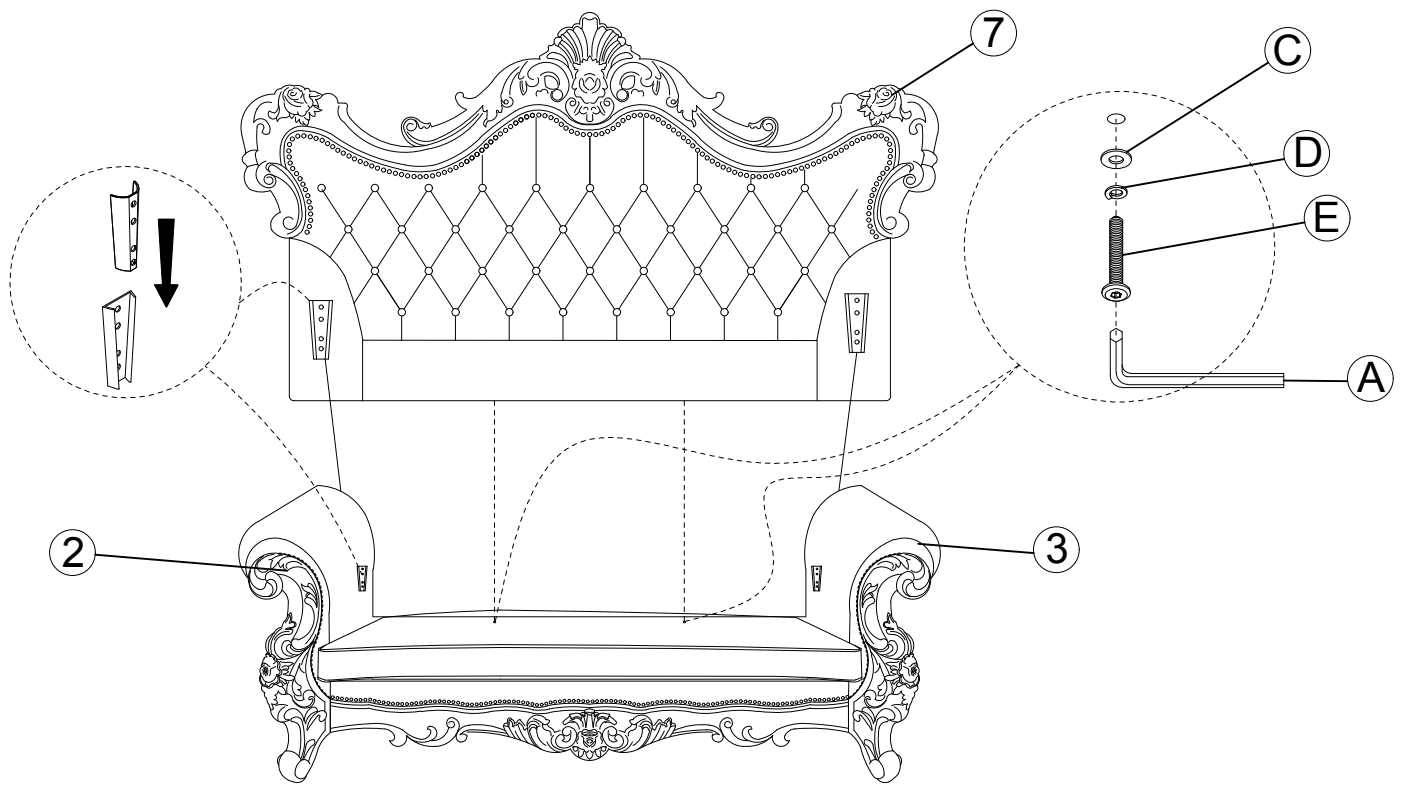

STEP 5:

Place the seat cushion (4), (5), (6) on to the seat frame (1).

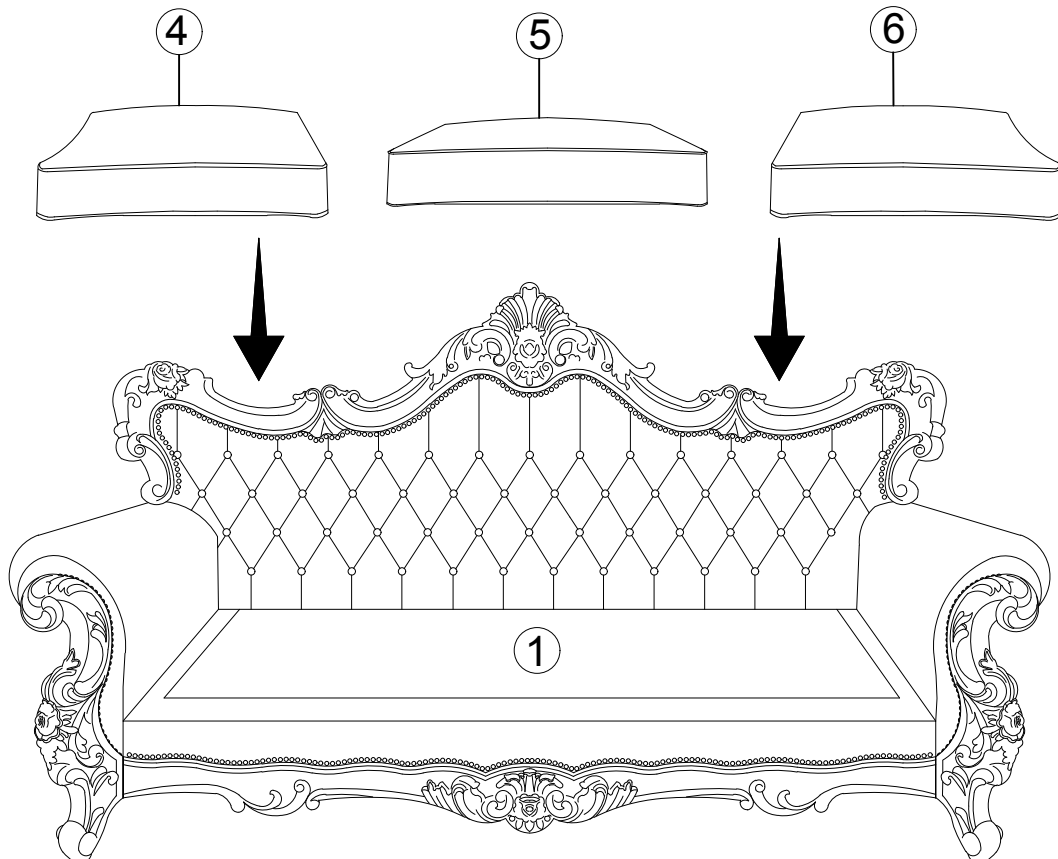

COMPLETE :

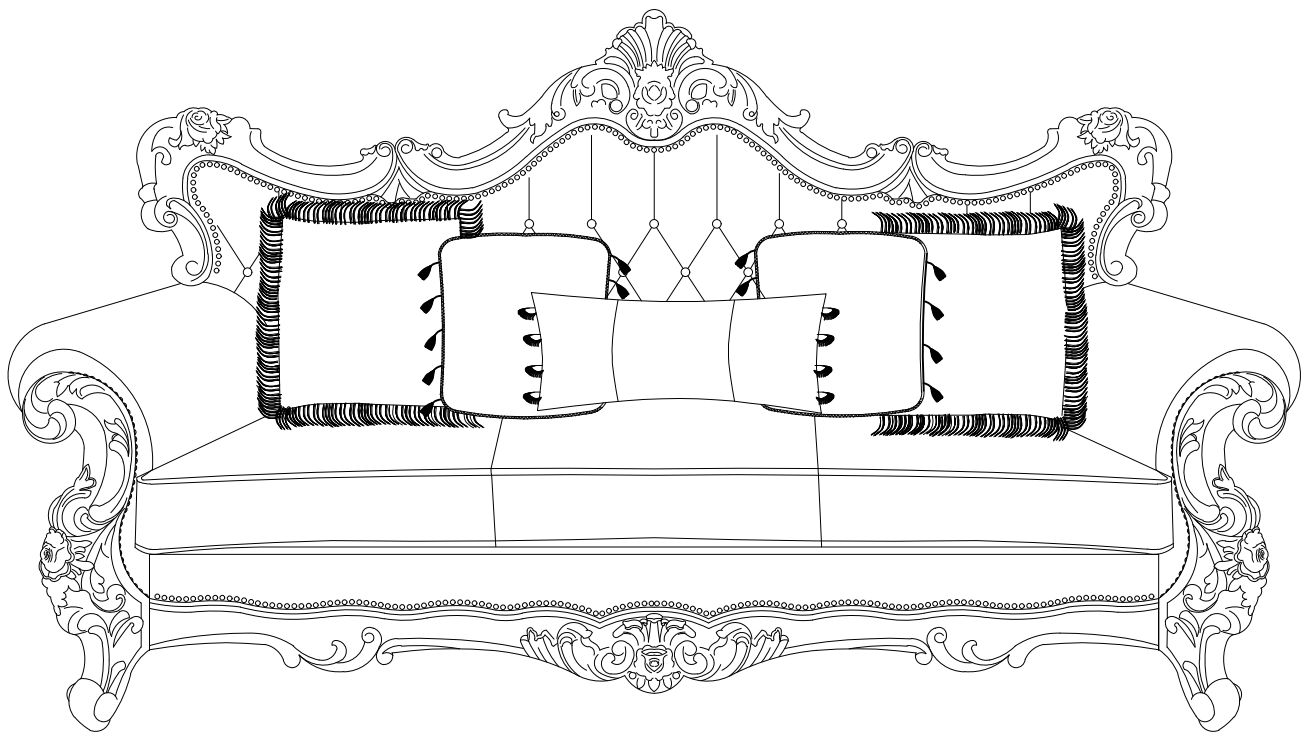

CARE INSTRUCTION FOR POLYESTER:

In order to maintain the original appearance of your polyester furniture, please follow below simple care procedure:

- Avoid exposing furniture directly to sunlight or heating and air conditioning outlets. Exposure to sunlight or heating and air conditioning outlets will fade/damage polyester.
- Wipe gently with a damp soft cloth to remove dust, dirt and any grime build up.
- Hardware may loosen over time. Periodically check to make sure all connections are tight. Re-tighten if necessary.