



## Assembly Instruction



9419/BU/BLK-30G:COCKTAIL TABLE GLASS TOP  
9419/BU/BLK-30:COCKTAIL TABLE BASE





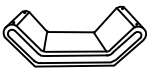
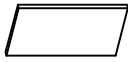

Legs and hardware are packed in a small box and placed on cocktail table base. Please take out for assembly.

NOTE:Do not use power tools for assembly. Power tools increase the risk of over tightening which leads to splitting or cracking the wood.

### PARTS LIST

NO.	DRAWING	QTY	DESCRIPTION
A		1PC	COCKTAIL TABLE BASE
B		1PC	GLASS TOP
C		4PCS	METAL LEGS 2.28"W*4.33"D*4.13"H

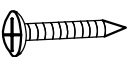
### HARDWARE LIST

NO.	DRAWING	QTY	DESCRIPTION
HARDWARE SET IS PACKED IN -30			
1		4PCS	BOLT Ø1/4"X1"
2		4PCS	FLAT WASHER Ø1/4"X16MM
3		4PCS	SPRING WASHER
4		16PCS	SCREW #10"X1-1/4"
5		1PC	ALLEN KEY
6		4PCS	GLASS HOLDER

STEP#1

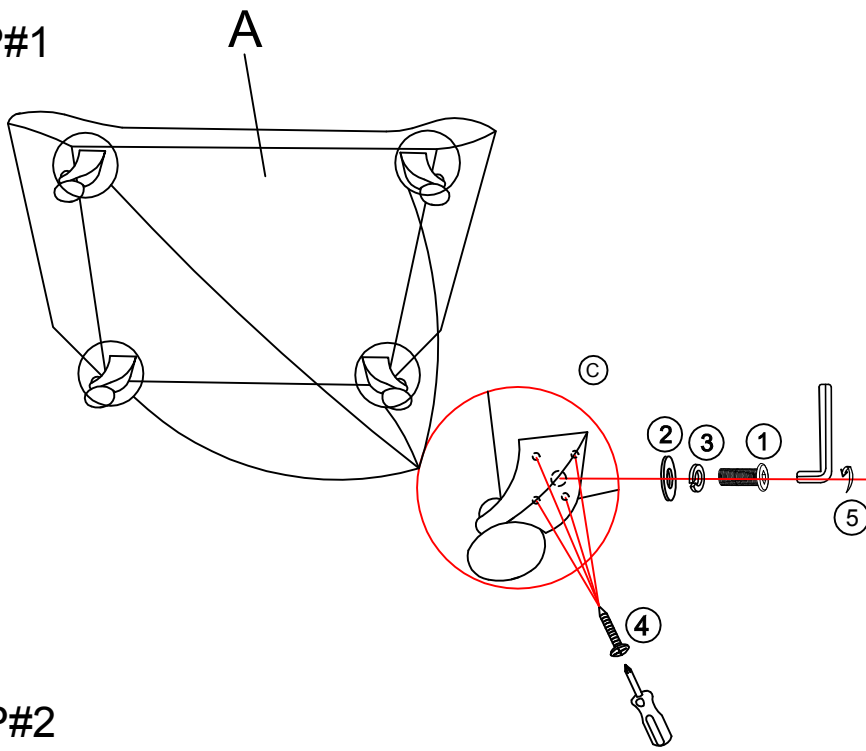

STEP#2

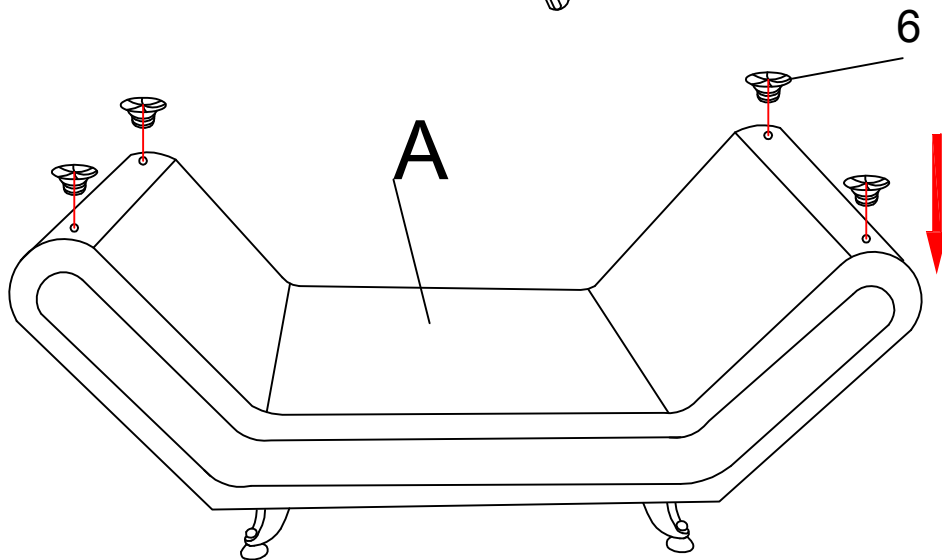

STEP#3

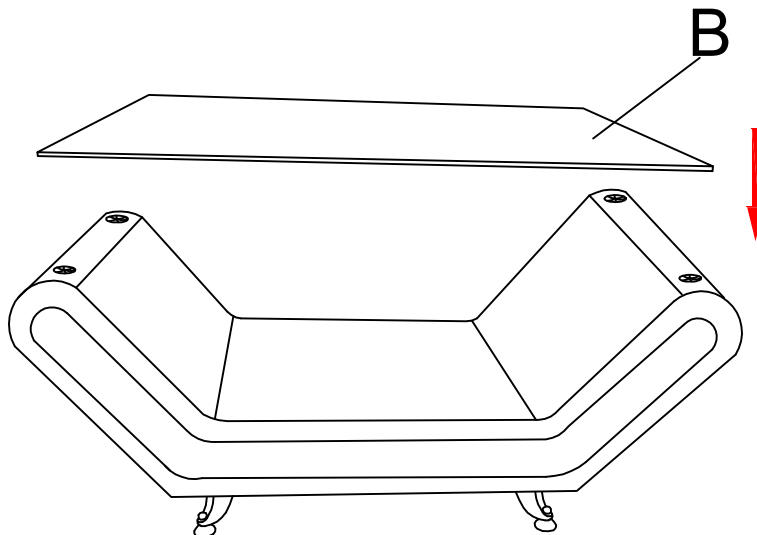

STEP#4  
Completed.

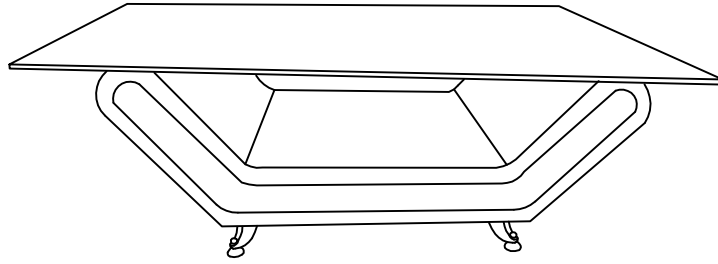

#### CARE INSTRUCTION FOR PU:

In order to maintain the original appearance of your PU furniture, please follow below simple care procedure:

- Avoid exposing furniture directly to sunlight or heating and air conditioning outlets. Exposure to sunlight or heating and air conditioning outlets will fade/damage PU.
- Wipe gently with a damp soft cloth to remove dust, dirt and any grime build up.



It is recommended to install protective pads under all legs and supports to avoid damage or scratches when placing furniture on a wood floor or other hard surface, and to limit indentation and prevent discoloration if placing on carpet.



Il est recommandé de placer des coussins protecteurs sous tous les pieds et toutes les bases des meubles pour éviter d'endommager ou d'égratigner les planchers en bois ou autres surfaces dures, et pour limiter l'empreinte et empêcher la décoloration quand les meubles reposent sur la moquette.