



# ASSEMBLY INSTRUCTION







ITEM NO: 9746DG/BE-1

## CHAIR

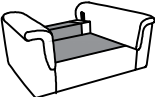



NOTE: Do not use power tools for assembly. The use of power tools increases the risk of over-tightening, which can result in wood splitting or cracking.

### TOOLS REQUIRED : NO TOOLS REQUIRED

NO.	DRAWING	QTY	DESCRIPTION
A		1	CHAIR BASE
B		1	BACK REST
C		1	LSF EAR
D		1	RSF EAR
E		1	SEAT CUSHION
F		1	BACK CUSHION

### HARDWARE LIST

NO.	DRAWING	QTY	DESCRIPTION
1		4	PLASTIC LEGS (8CM)
2		4	WASHERS (Ø4.7CM)

STEP 1

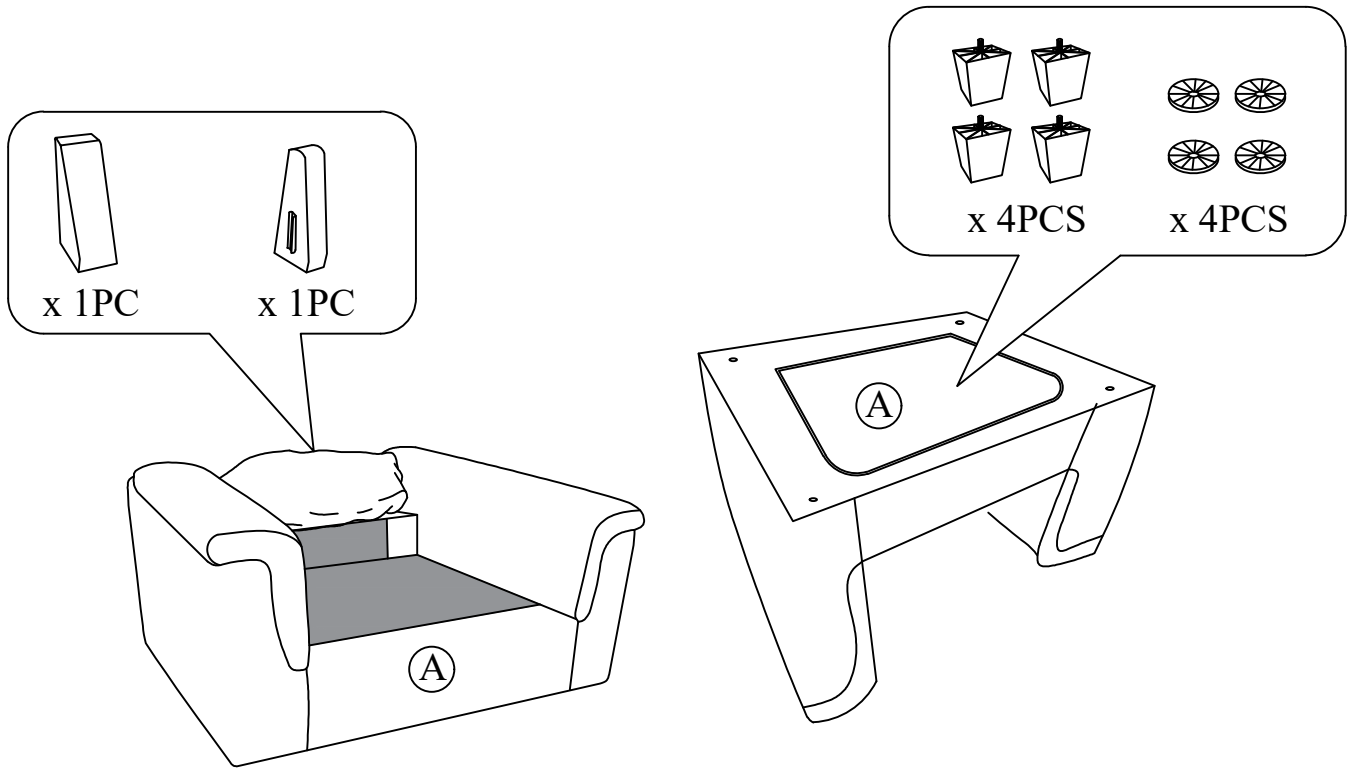

STEP 2

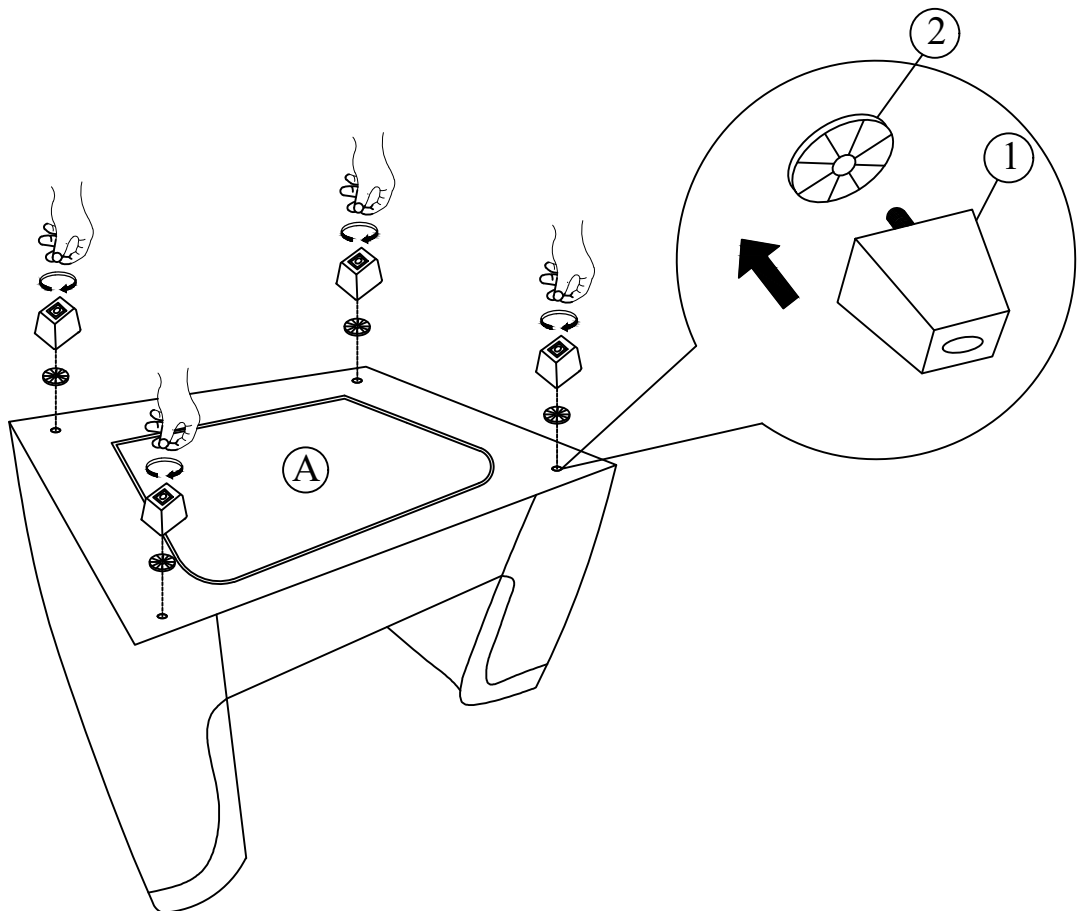

STEP 3

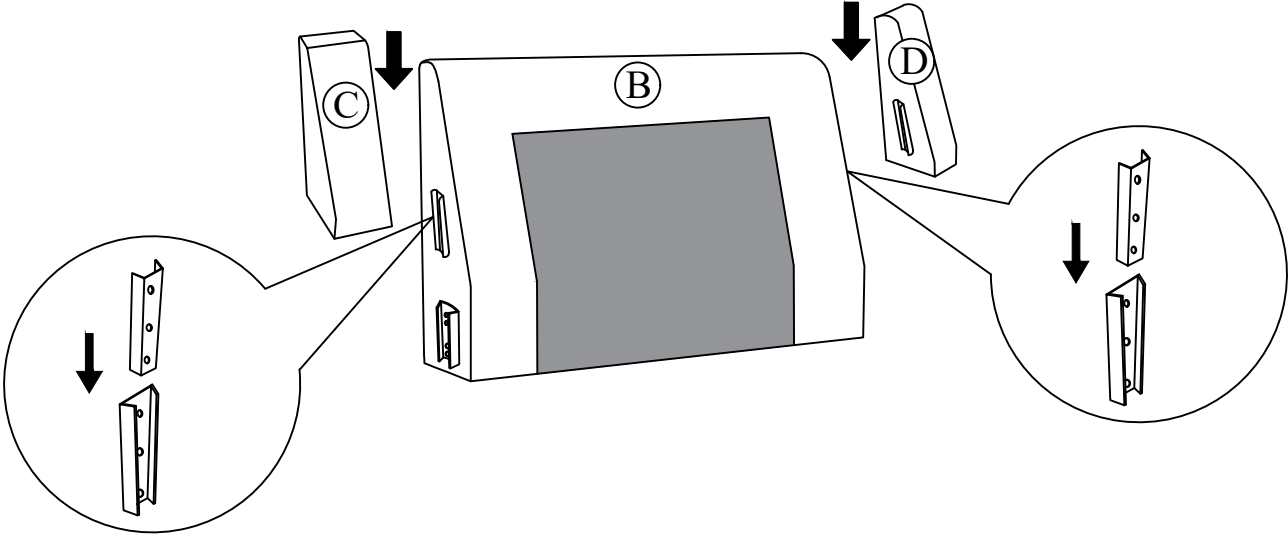

STEP 4

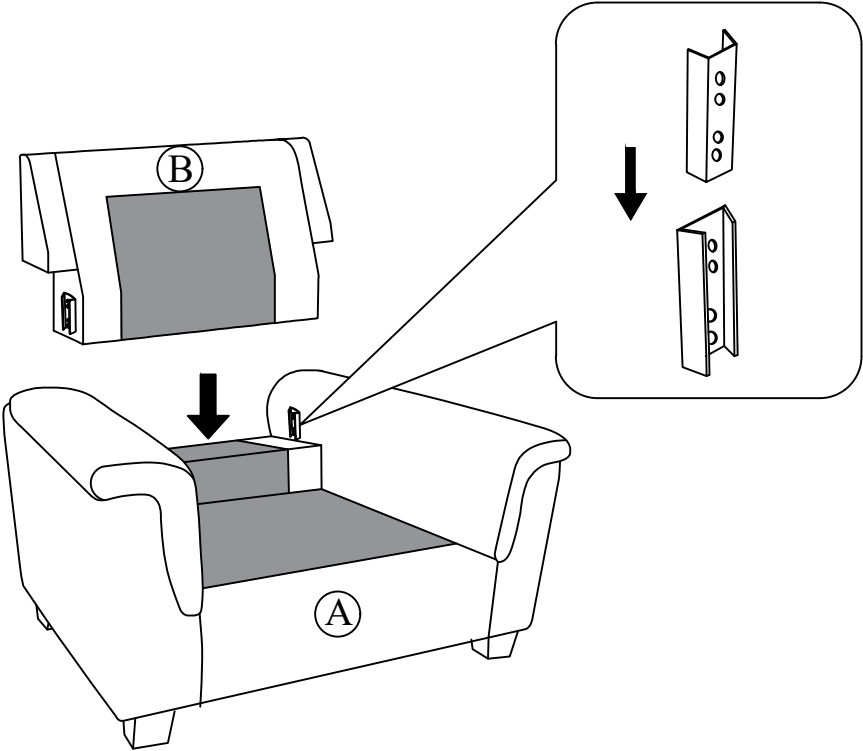

STEP 5

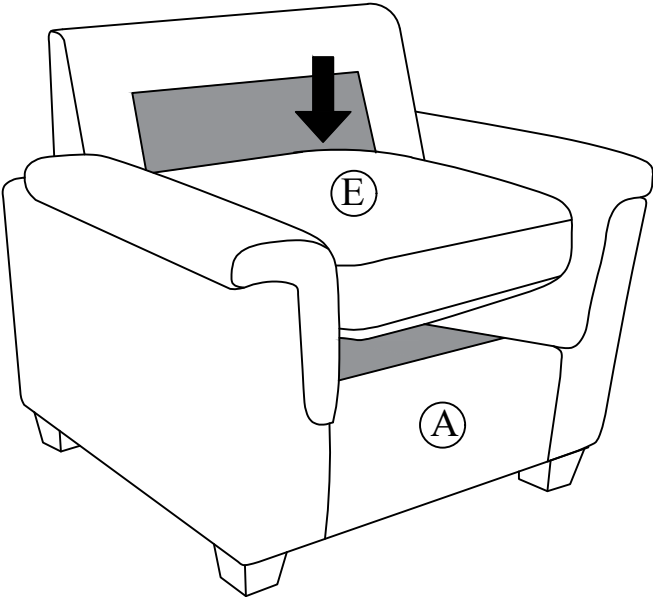

STEP 6

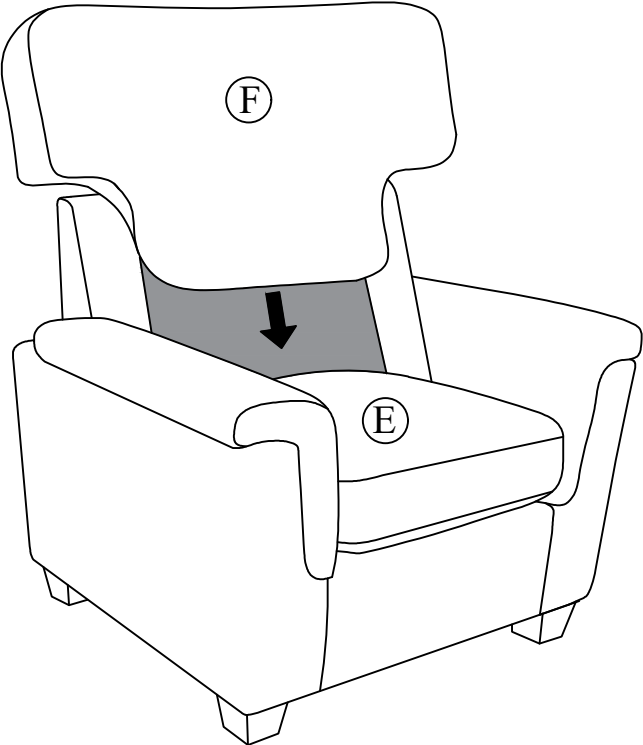

COMPLETED

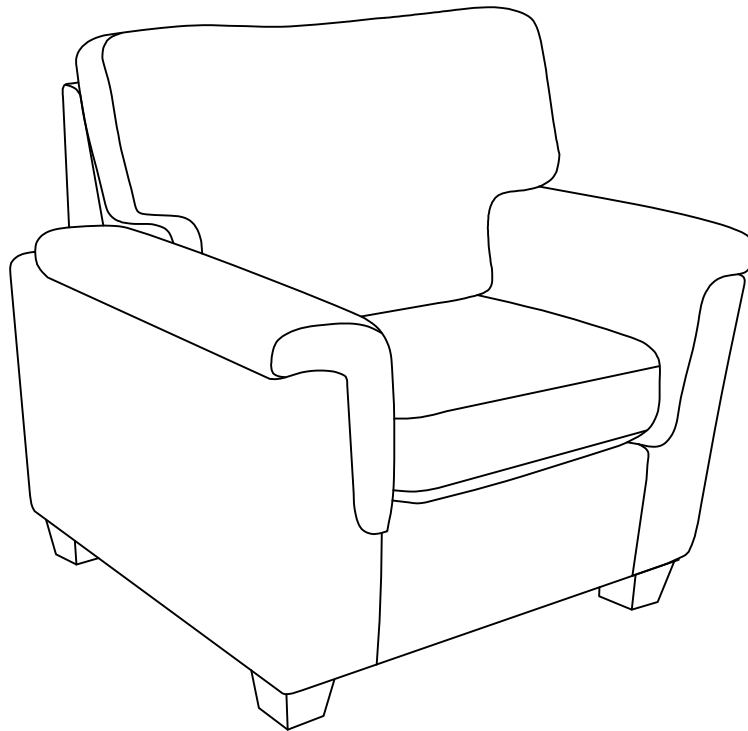

**Care Instruction for Chenille Furniture.**

In order to maintain the original appearance of your Chenille furniture, please follow below simple care procedures:

- Avoid exposing furniture directly to sunlight or heating and air conditioning outlets. Sunlight and/or exposure to heating and air conditioning outlets will fade/damage Chenille.
- Do not place your Chenille furniture too close to windows, radiators, or vents.
- Vacuum or wipe with a soft brush to remove dust.
- Hardware may loosen over time. Periodically check to make sure all connections are tight, Re-tighten if necessary.



**For items use on wooden floor, hard surfaces or carpets, it is recommended to install protective pads under all legs and supports to avoid/prevent from damages/scratches and discoloration.**