



ASSEMBLY INSTRUCTION







ITEM NO: 9746DG/BE-2

LOVE SEAT (WITH 2 PILLOWS)

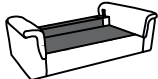
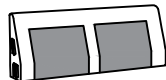



NOTE: Do not use power tools for assembly. The use of power tools increases the risk of over-tightening, which can result in wood splitting or cracking.

TOOLS REQUIRED : NO TOOLS REQUIRED

| NO. | DRAWING | QTY | DESCRIPTION |
|-----|---|-----|-------------------|
| A |  | 1 | LOVE SEAT BASE |
| B |  | 1 | BACK REST |
| C |  | 1 | LSF EAR |
| D |  | 1 | RSF EAR |
| E |  | 2 | SEAT CUSHION |
| F |  | 1 | LSF BACK CUSHION |
| G |  | 1 | RSF BACK CUSHION |
| H |  | 2 | PILLOWS (19"x19") |

HARDWARE LIST

| NO. | DRAWING | QTY | DESCRIPTION |
|-----|---|-----|--------------------|
| 1 |  | 4 | PLASTIC LEGS (8CM) |
| 2 |  | 4 | WASHERS (Ø4.7CM) |

STEP 1

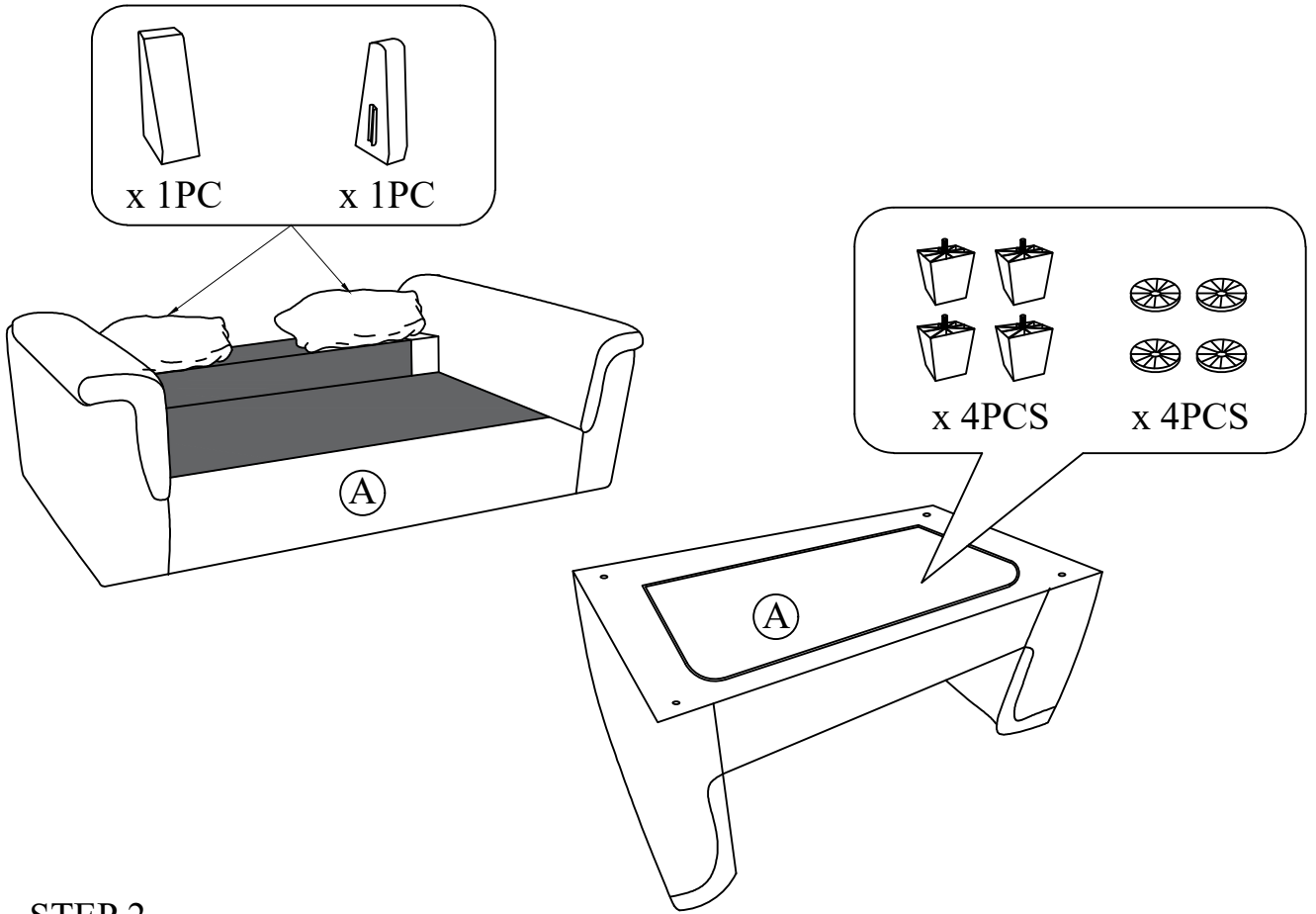

STEP 2

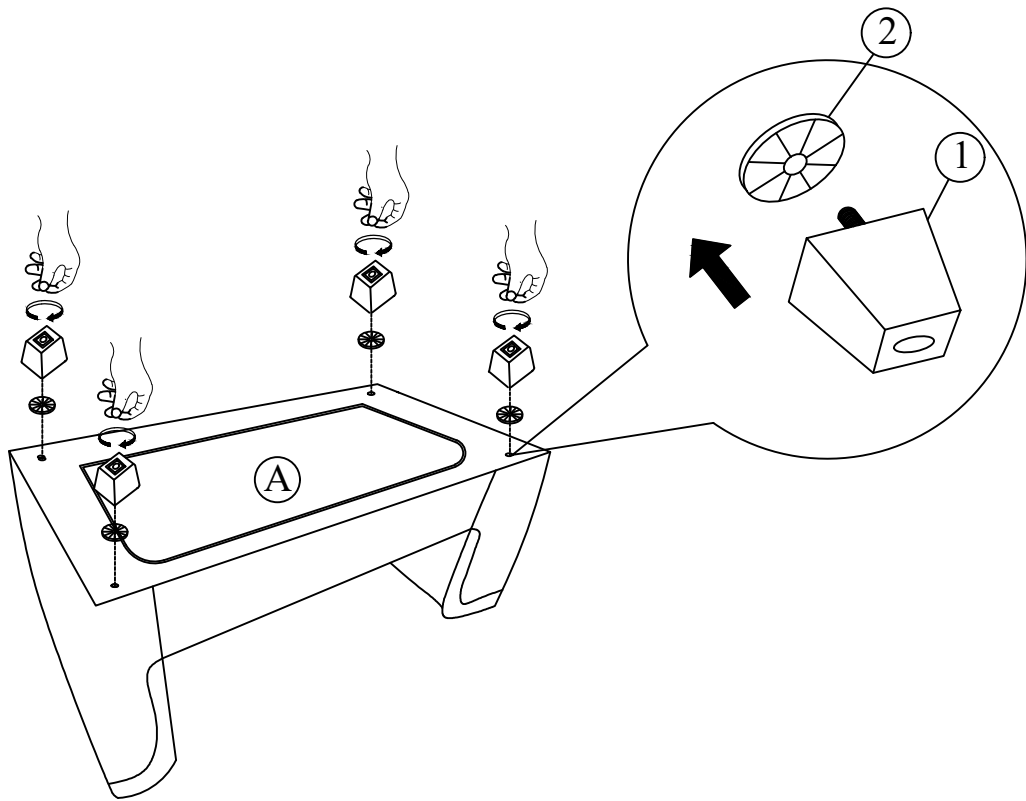

STEP 3

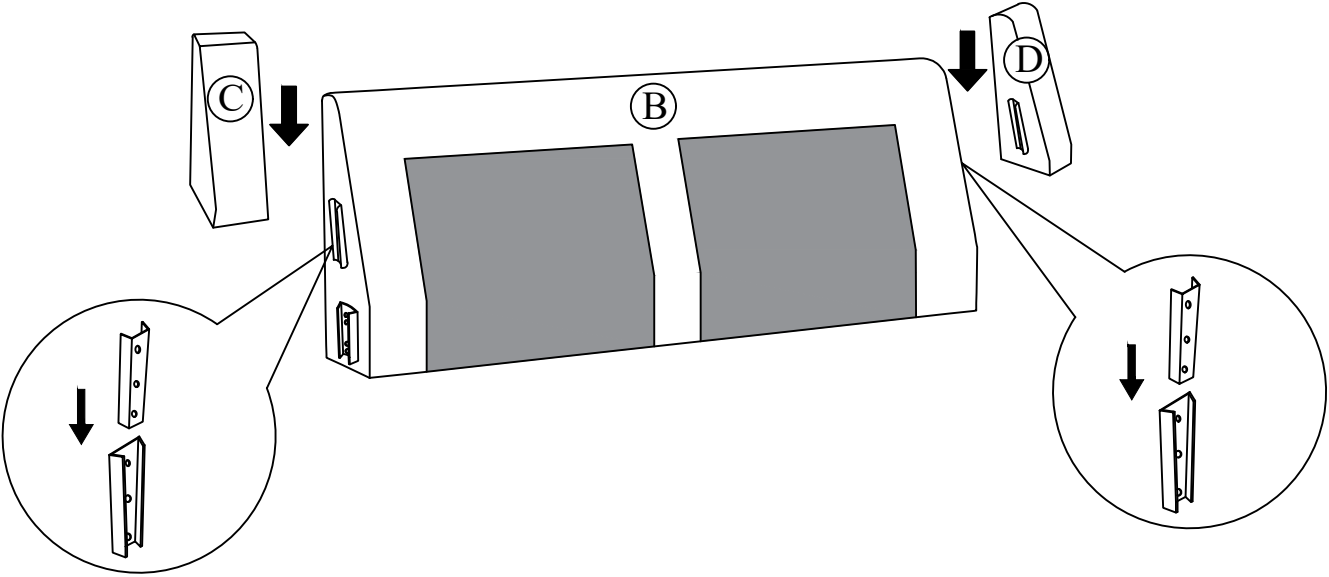

STEP 4

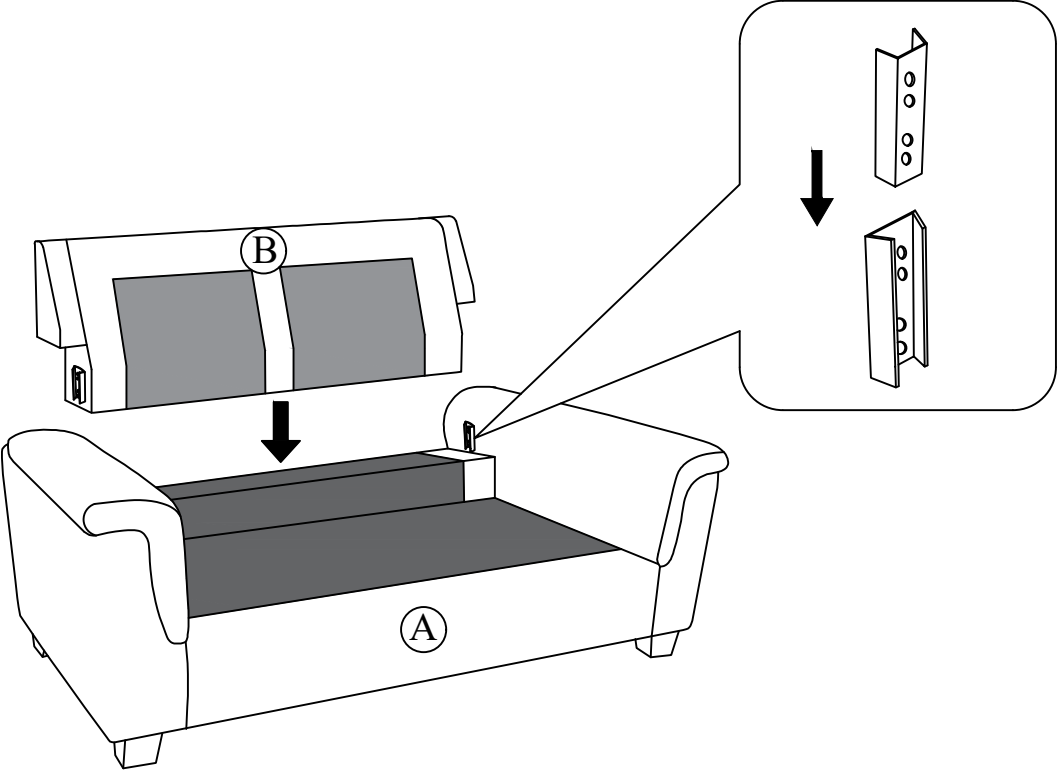

STEP 5

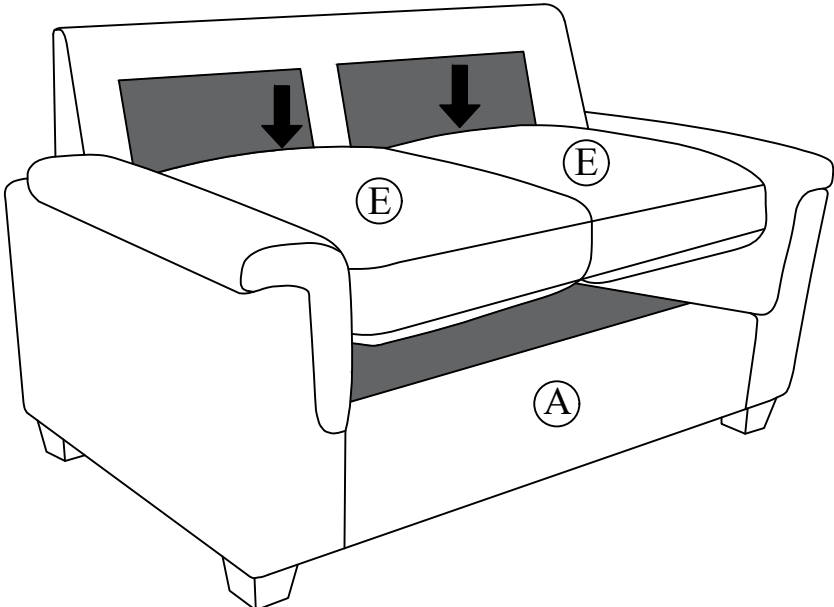

STEP 6

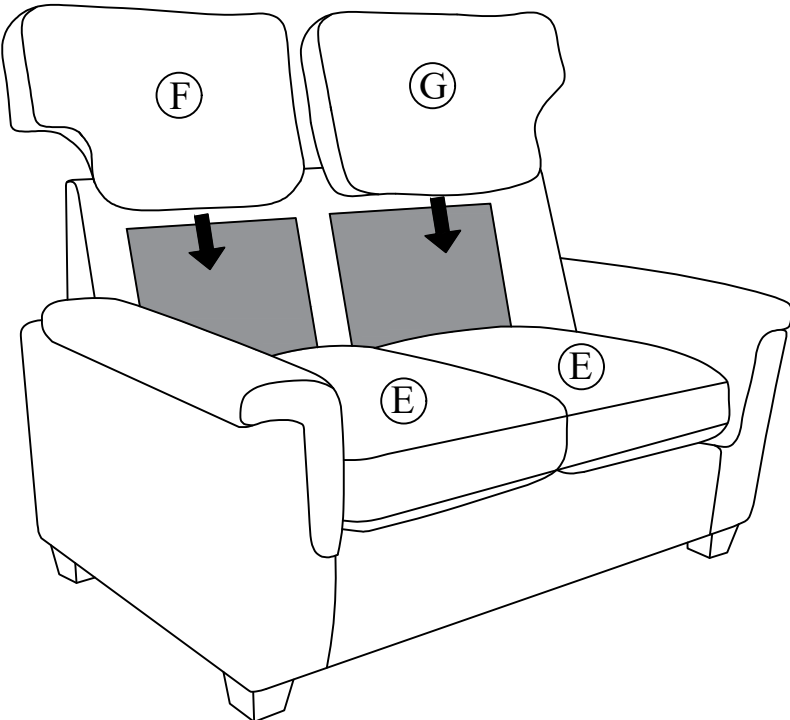

COMPLETED

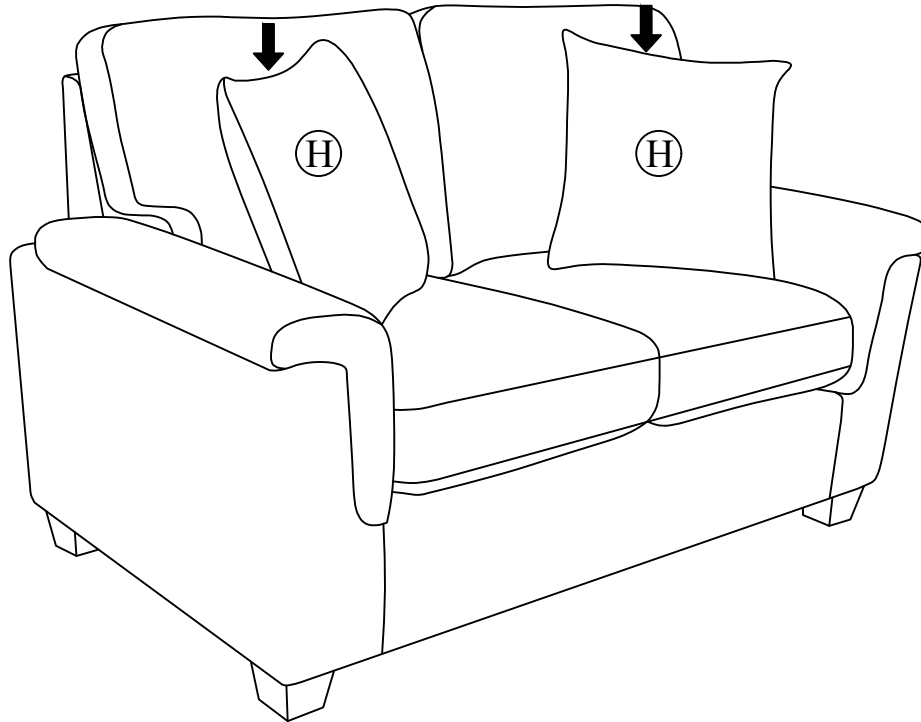

Care Instruction for Chenille Furniture.

In order to maintain the original appearance of your Chenille furniture, please follow below simple care procedures:

- Avoid exposing furniture directly to sunlight or heating and air conditioning outlets. Sunlight and/or exposure to heating and air conditioning outlets will fade/damage Chenille.
- Do not place your Chenille furniture too close to windows, radiators, or vents.
- Vacuum or wipe with a soft brush to remove dust.
- Hardware may loosen over time. Periodically check to make sure all connections are tight, Re-tighten if necessary.



For items use on wooden floor, hard surfaces or carpets, it is recommended to install protective pads under all legs and supports to avoid/prevent from damages/scratches and discoloration.