

ASSEMBLY INSTRUCTION

2546-96 DINING TABLE

PART LIST:

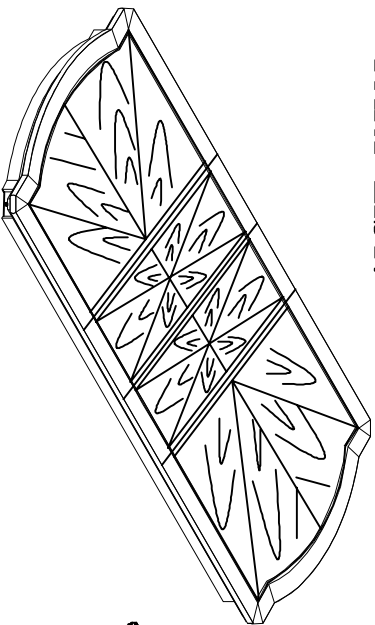

Table top
1pc

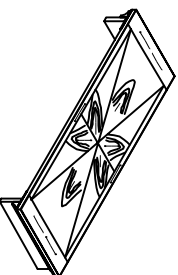

Table leaf
2 pcs

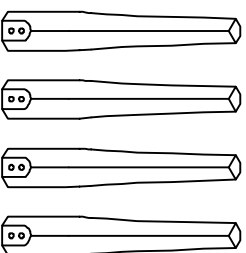



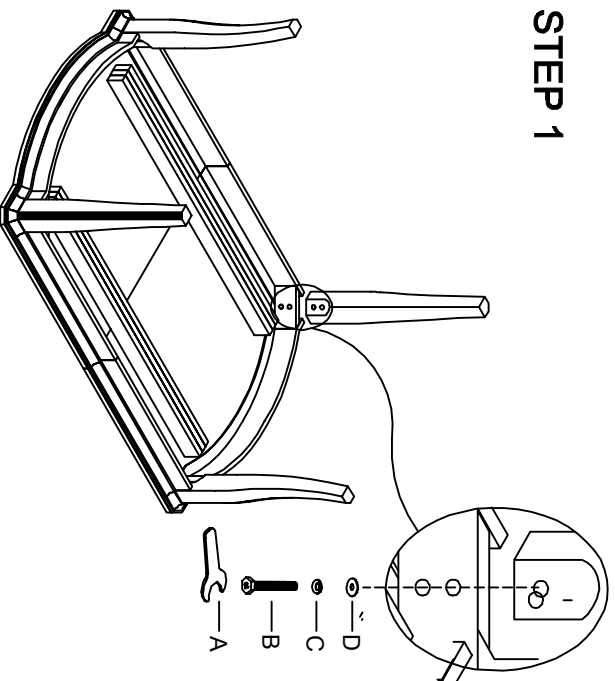

Table leg
4pcs

HARDWARE LIST				
A		L-ALLEN KEY	12mm	1 PC
B		Bolt	Ø5/16"x2"	8 PCS
C		Spring Washer	Ø5/16"	8 PCS
D		Flat Washer	Ø5/16"xØ23mm	8 PCS

STEP 1



STEP 2

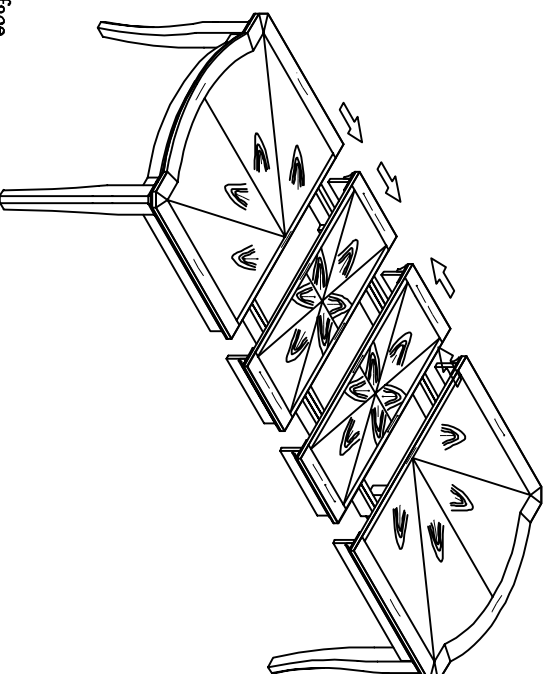

COMPLETED

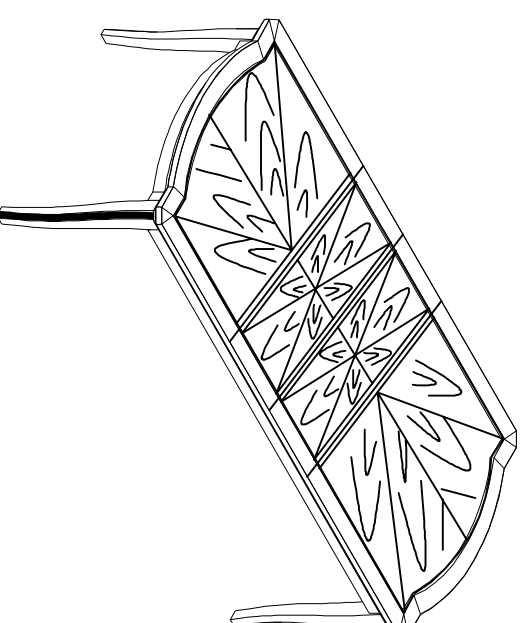

- (1) Place the table top on the smooth and stable carpeted or padded surface.
- (2) Align the table legs to the pre-drilled holes and tighten with bolt and washer.
- (3) Insert the leaves to the table top and push to close it smoothly.