









ASSEMBLY INSTRUCTION

ITEM NO: 710 -54B / 710-54C

DINING TABLE

NO	Description	Drawing	Size	Q' ty
A	Wrench		Ø M17mm	1 pc
B	Hex Nut		Ø M10mm	8 pcs
C	Spring Washer		Ø M12mm	8 pcs
D	Flat Washer		Ø M18mm	8 pcs
E	Allen Key			1 pc
F	JCBC Bolt		Ø M6mm	4 pcs
G	Bracket			4 pcs
H	Cap nut (for shelf)		Ø M6mm	4 pcs

Step 1

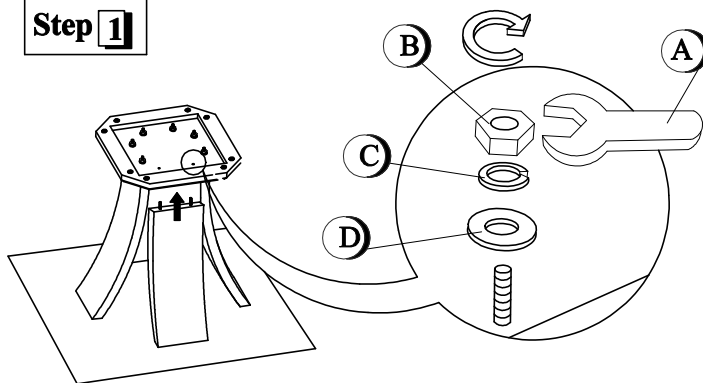

Turn table upside down on a smooth, soft surface.

Step 2

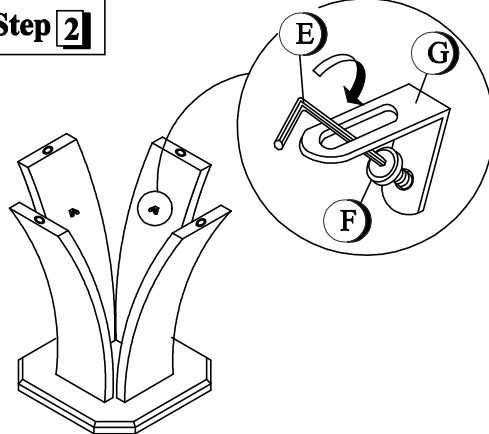

Step 3

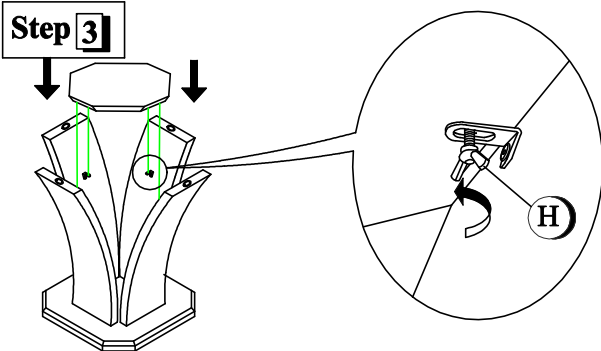

Step 4

