

# Assembly Instruction

ITEM NO.: 9623GY/9623BE-LU











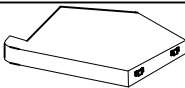

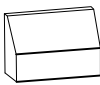
(1/4)Left Side Cuddler

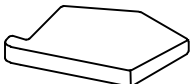

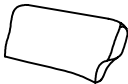
Legs & hardware are stored in the box, please take out the legs and hardware for assembly.

Note: Do not use power tools for assembly. Power tools increase the risk of over tightening which lead to splitting or cracking the wood.

## Chair Component list

No	Drawing	Qty	Description
<b>A</b>		<b>1</b>	<b>SEAT BASE</b>
<b>B</b>		<b>1</b>	<b>RSF BACKREST</b>
<b>C</b>		<b>1</b>	<b>LSF BACKREST</b>
<b>D</b>		<b>1</b>	<b>ARMREST</b>
<b>E</b>		<b>1</b>	<b>SEAT CUSHION</b>
<b>F</b>		<b>1</b>	<b>RSF BACK CUSHION</b>
<b>G</b>		<b>1</b>	<b>LSF BACK CUSHION</b>
<b>H</b>		<b>2</b>	<b>PILLOW (17"*17")</b>
<b>I</b>		<b>1</b>	<b>WOODEN LEG (120*120*50mm)</b>
<b>J</b>		<b>4</b>	<b>WOODEN LEGS (120*50*50mm)</b>
<b>K</b>		<b>23</b>	<b>ALLEN BOLT (5/16"*70mm)</b>
<b>L</b>		<b>23</b>	<b>FLAT WASHER (1/4"*Ø19*1.5mm)</b>
<b>M</b>		<b>1</b>	<b>ALLEN KEY (M4*59mm)</b>

# THE PARTS ARE LOCATED INSIDE THE BOX AS BELOW:

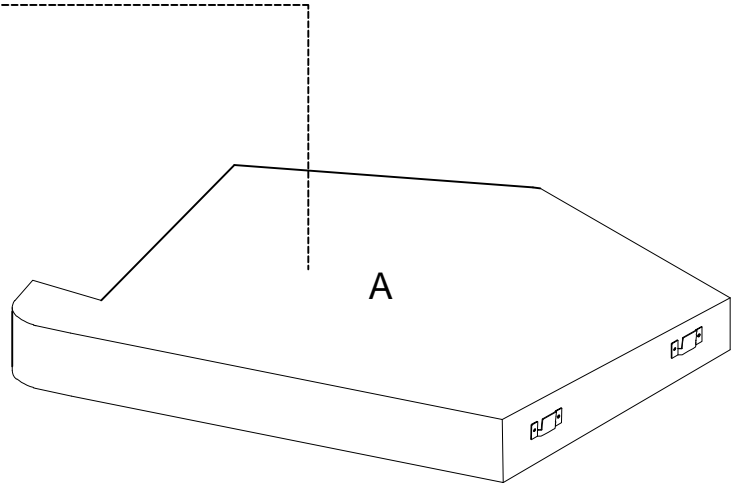
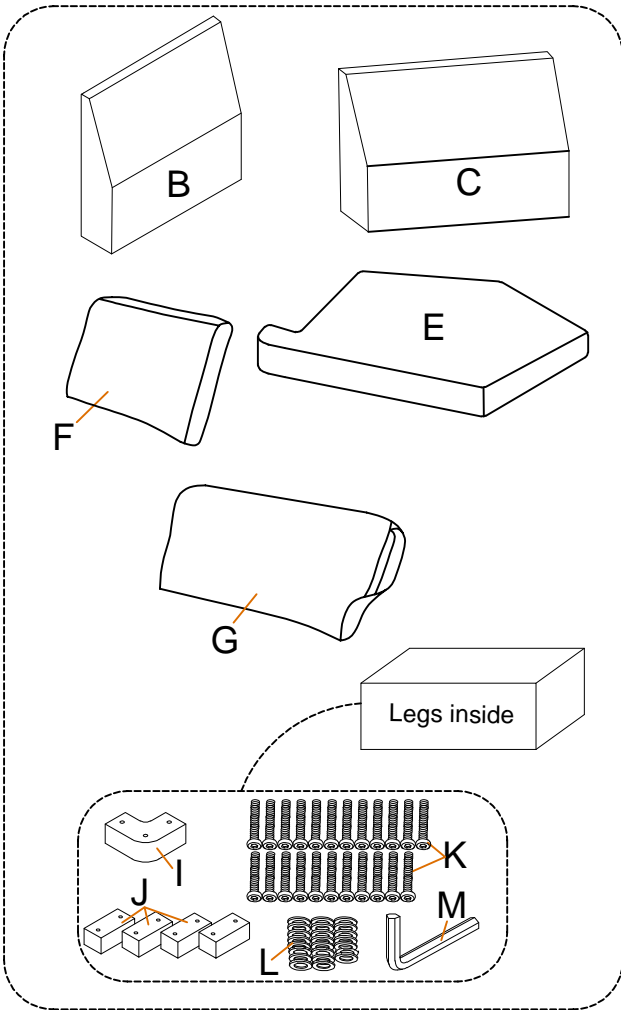
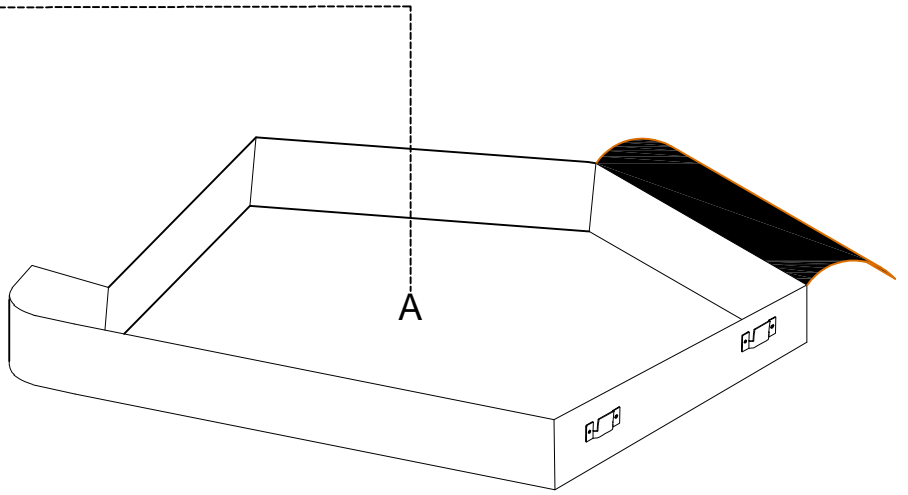
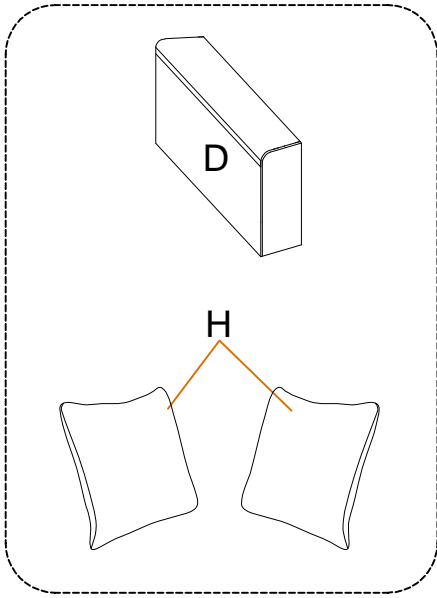

# Step #1

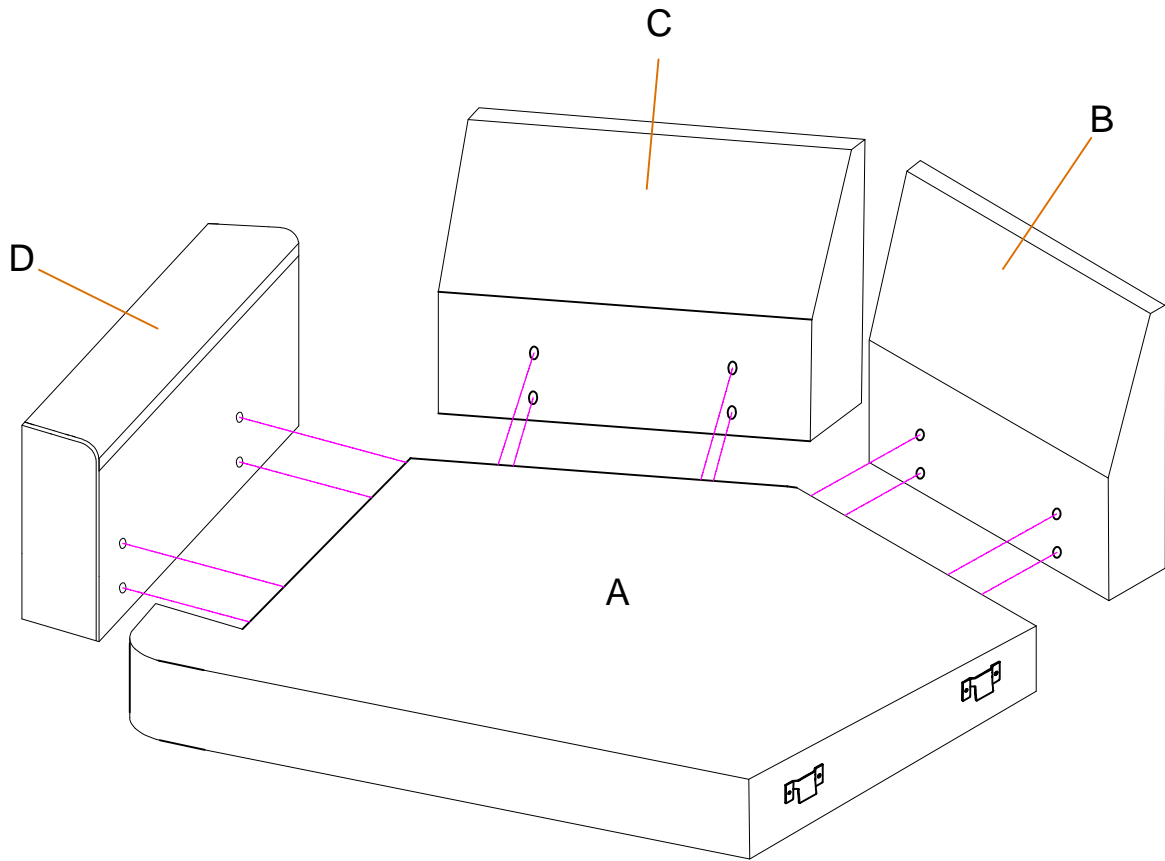

# Step #2

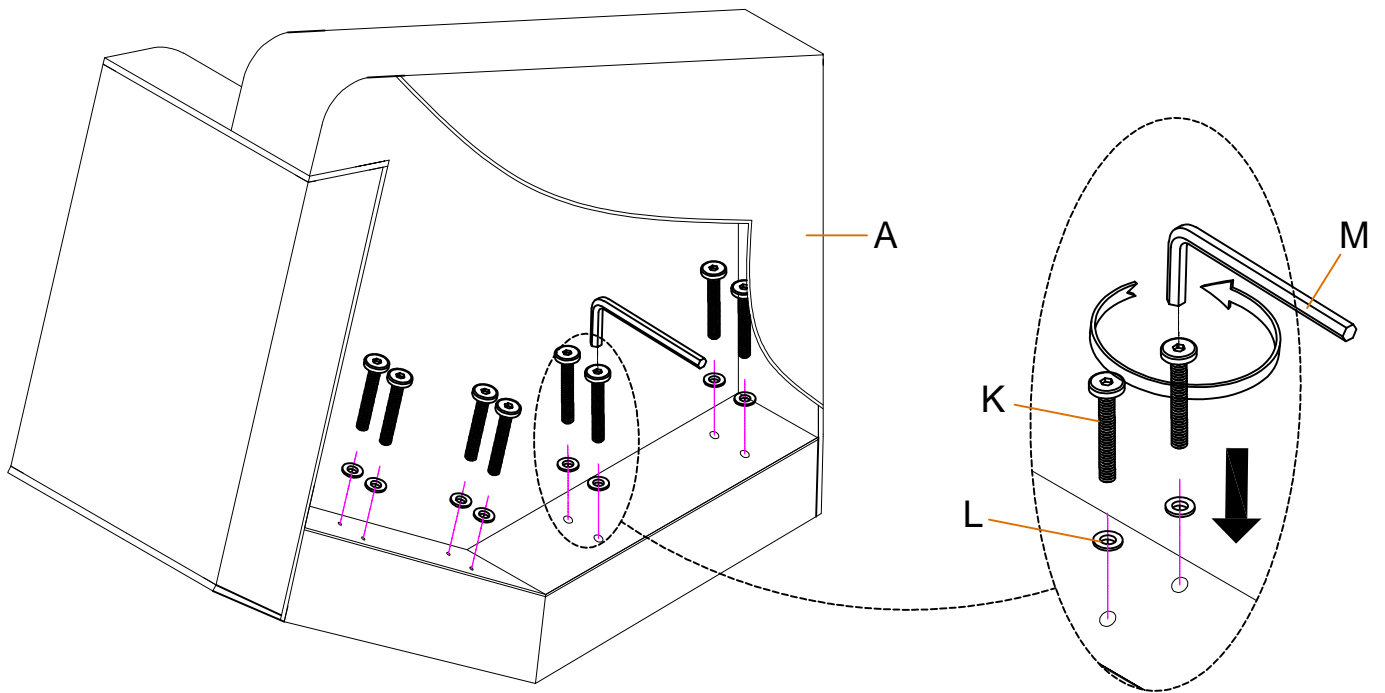

### Step #3

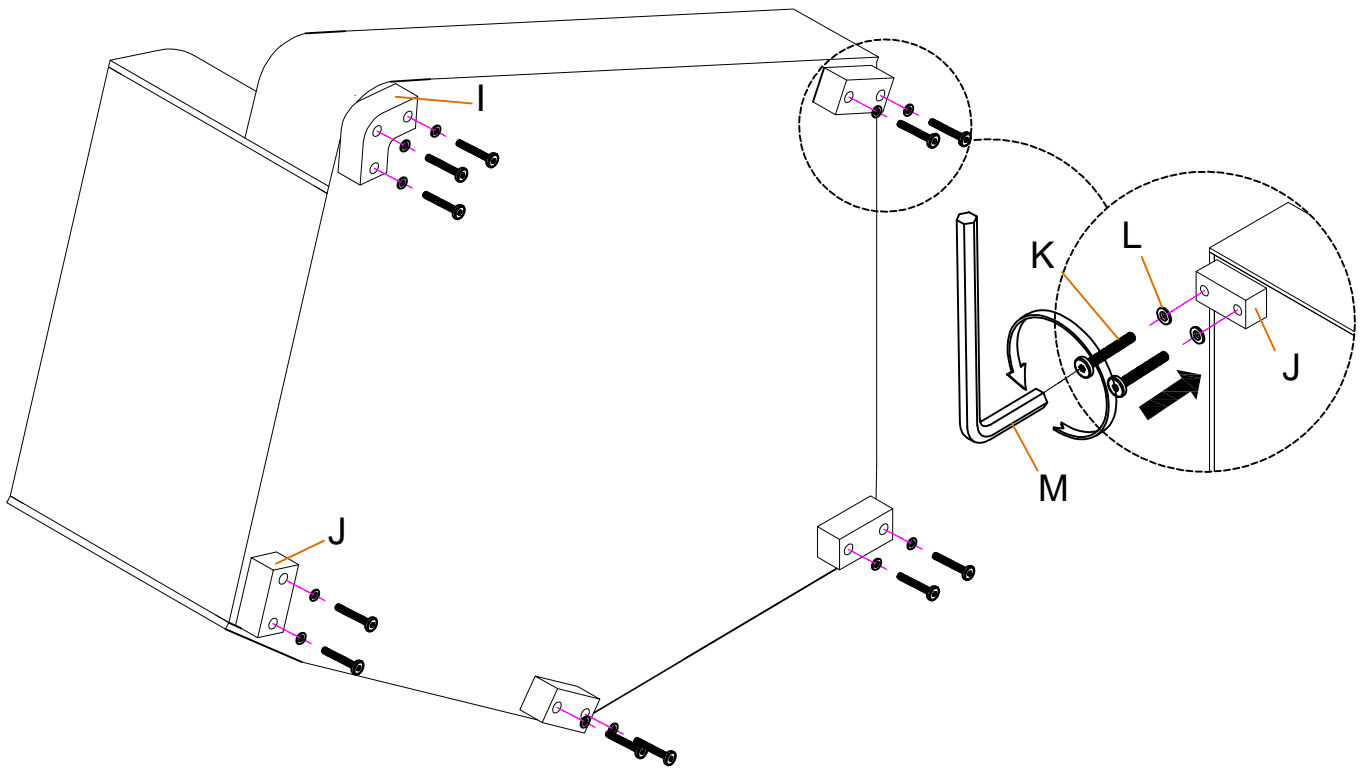

### Step #4

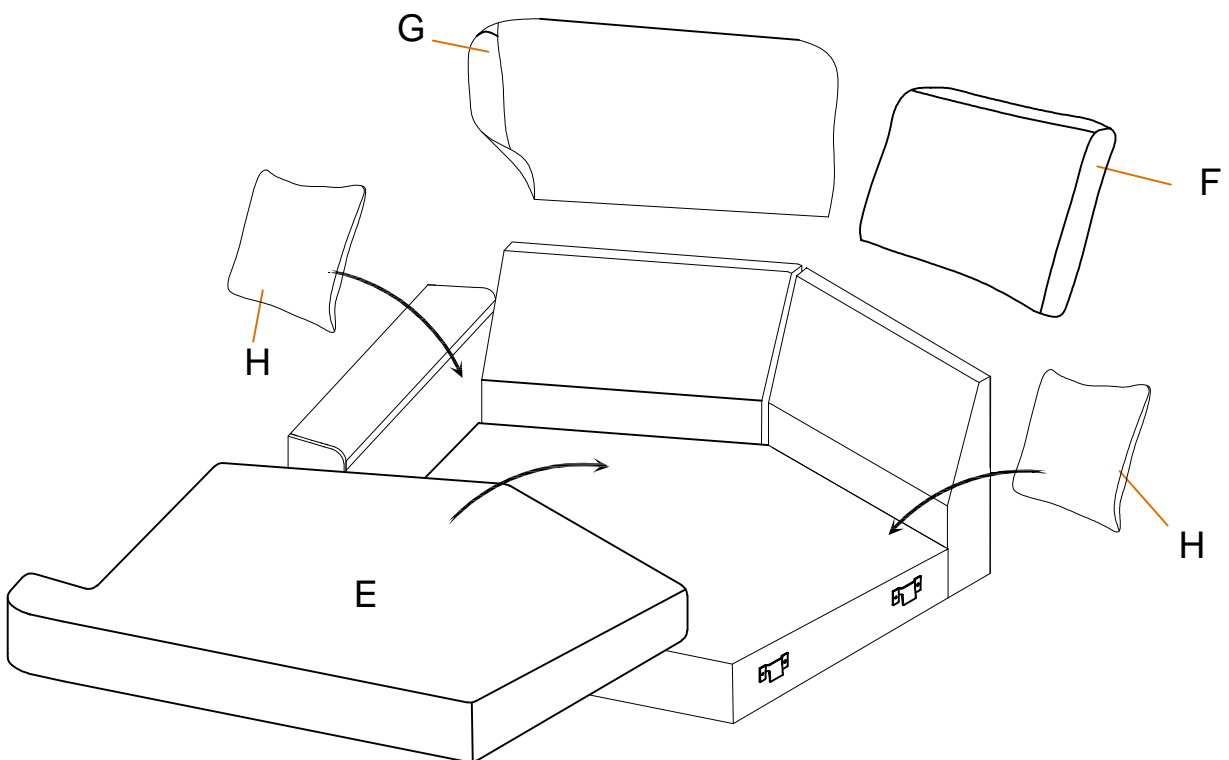

Step #5

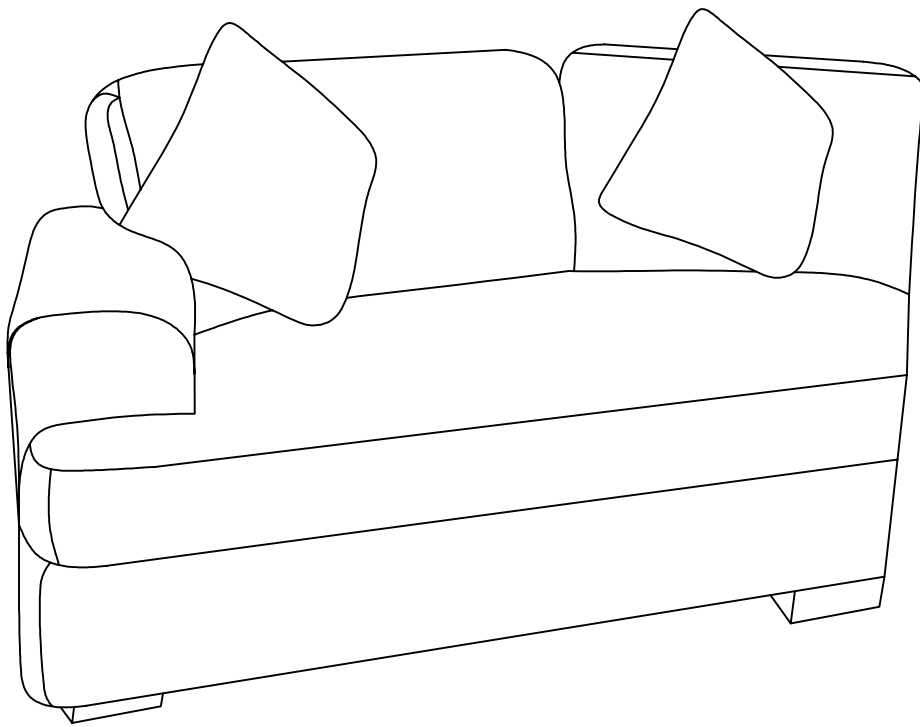

Step #6

9623GY/BE-LU

9623GY/BE-2A

9623GY/BE-CR

9623GY/BE-2R

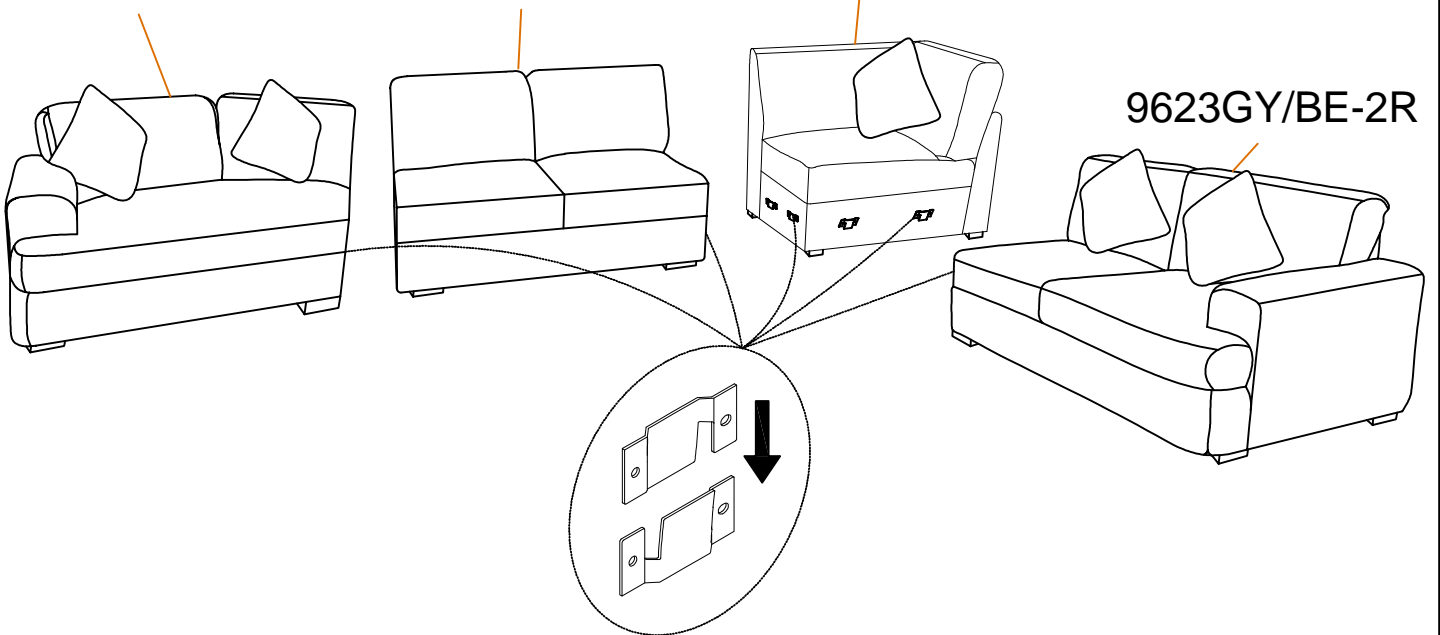

## Step #7

Assembly completed.

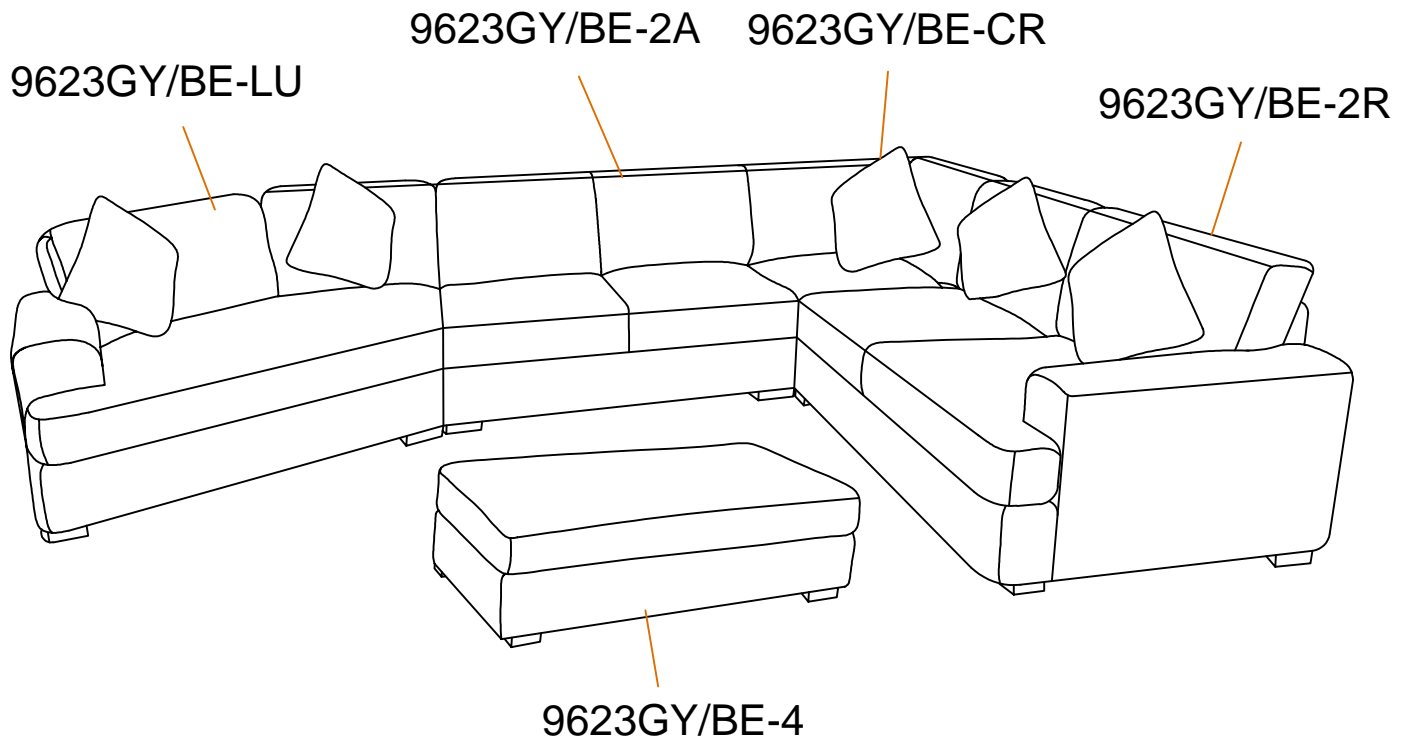

## Care Instruction for Corduroy Furniture:

In order to maintain the original appearance of your corduroy, please follow below simple care procedures:

- Avoid exposing furniture directly to sunlight or heating and air conditioning outlets. Sunlight and/or exposure to heating and air conditioning outlets will fade/damage corduroy. Do not place your upholstered furniture too close to windows, radiators, or vents, and be sure to use windows, radiators, or vents.
- Vacuum or wipe with a soft cloth to remove dust.
- Hardware may loosen over time. Periodically check to make sure all connections are tight. Re-tighten if necessary.



For items use on wooden floor, hard surfaces or carpets, it is recommended to Install protective pads under all legs and supports to avoid/prevent from damages/scratches and discoloration.