





Assembly Instruction

ITEM NO.: 9634DGY-1
RECLINING CHAIR

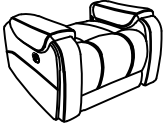
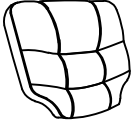

Note: Do not use power tools for assembly. Power tools increase the risk of over tightening which lead to splitting or cracking the wood.

Component list

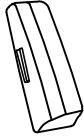
No	Drawing	Qty	Description
A	 A line drawing of a chair seat, showing a rectangular shape with rounded corners and a small rectangular detail on the left side.	1	SEAT
B	 A line drawing of a chair backrest, showing a rectangular shape with rounded corners and a small rectangular detail on the left side.	1	BACK REST
C	 A line drawing of a chair earrest, showing a rectangular shape with rounded corners and a small rectangular detail on the left side.	1	LSF EAR
D	 A line drawing of a chair earrest, showing a rectangular shape with rounded corners and a small rectangular detail on the left side.	1	RSF EAR

Step #1

**EARS ARE STORED
UNDER METAL FRAME**

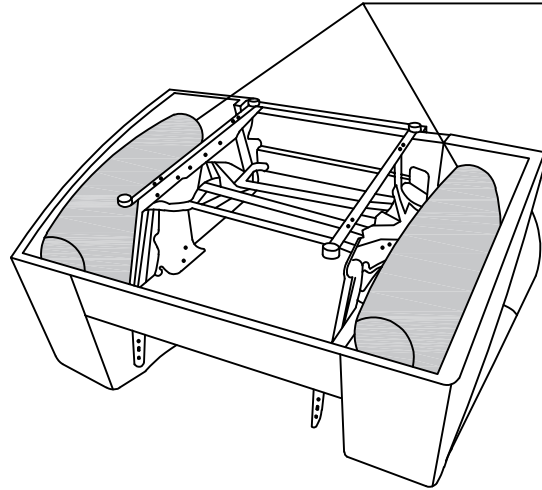

Step #2

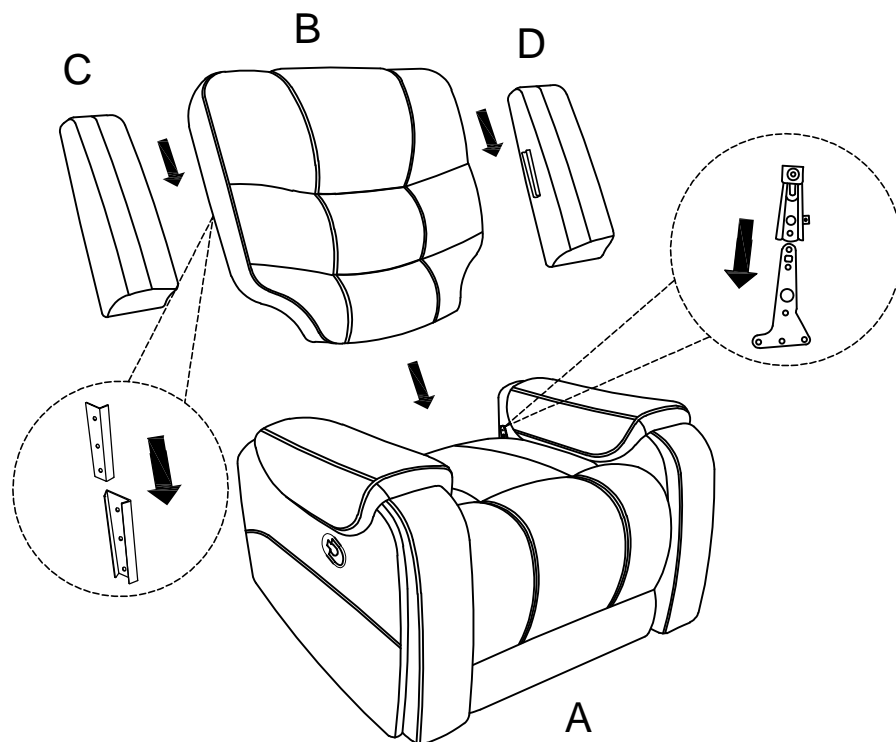

Step #3

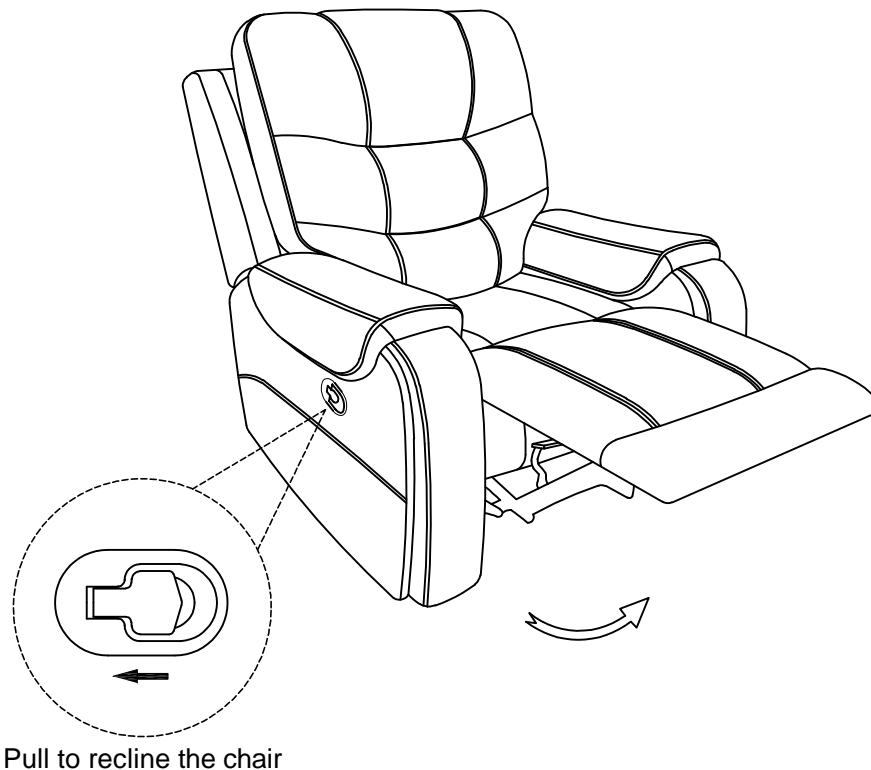

Care Instruction for Polished Microfiber Furniture:

In order to maintain the original appearance of your Polished Microfiber Furniture, please follow below simple care procedures:

- Avoid exposing furniture directly to sunlight or heating and air conditioning outlets. Sunlight and or exposure to heating and air conditioning outlets will fade/damage Polished Microfiber.
- Vacuum or wipe with a soft cloth to remove dust.
- Hardware may loosen over time. Periodically check to make sure all connection are tight, Re-tighten if necessary.



For items use on wooden floor, hard surfaces or carpets, it is recommended to Install protective pads under all legs and supports to avoid/prevent from damages/scratches and discoloration.